



DEE50102 PROJECT

FYP REPORT

RFID CAT CAGE DOOR

GROUP NAME

MUHAMMAD NURFADZLI BIN TUDI	DEP5A	08DEP17F1140
MUHAMAD ADHAM BIN MUHAMAD SAFAR	DEP5A	08DEP17F1198

SUPERVISOR'S NAME

1. PN NOR ROFIZAH BINTI ABDUL TALIB
2. PN MASRIANI BINTI MANSOR
3. PN MARLIANA BINTI RAMLI
4. PN JULAIHA BINTI OMAR

PENGESAHAN LAPORAN PROJEK

Laporan ini bertajuk “RFID Cat Cage Door” telah dikemukakan dan disemak serta disahkan sebagai memenuhi syarat dan keperluan penulisan projek seperti yang telah ditetapkan. Kami akui karya ini adalah hasil kerja kami sendiri kecuali nukilan yang setiap satunya telah kami jelaskan sumbernya.

Di semak oleh :-

Nama penyelia :

T / tangan penyelia :

Tarikh :

Di sahkan oleh:-

Nama Penyelaras :

T / tangan penyelaras :

Tarikh :

Nama : MUHAMMAD NURFADZLI BIN TUDI

No. pendaftaran : 08DEP17F1140

Tandatangan :

Tarikh :

Nama : MUHAMAD ADHAM BIN MUHAMAD SAFAR

No. pendaftaran : 08DEP17F1198

Tandatangan :

Tarikh :

ACKNOWLEDGEMENT

Praise be to Allah SWT for the owners of nature, be grateful for the Divine Presence for His Taqik and His guidance, has given my permission to complete the Final Year Project Report, my final year project report book is a tribute to all parties involved in helping and providing guidance useful when I complete my Final Year Project, during semester 4 until the 5th semester in 2019.

I want to take this opportunity to express my appreciation to all those who have a lot of helped my throughout my performing the final Year Project. I would like to extend my sincere gratitude to my supervisor, Pn Nor Rofizah binti Abdul Talib , for her assistance and guidance towards the progress of this thesis project. Throughout the year, Pn Nor Rofizah binti Abdul Talib has been patiently monitoring my progress and guided me in the right direction and offering encouragement. Obviously the progress I had now will be uncertain without her assistance.

And also not forget my teammate Muhamad Adham bin Muhamad Safar, who always be together from beginning to the end of Final Year Project to complete the project. I would like to thank you to Polytechnic Sultan Salahuddin Abdul Aziz Shah (PSA) and most of all I am very grateful to my family for their never failed encouragement and financial support they have given me over the years. I would like to thanks once again and may Allah bless us all.

ABSTRACT

Entry cage doors for cats can give pets the freedom to come and go, also releasing their owners from the time honored tradition of holding cage doors open. A cat cage door is found to be convenient by many owners of companion animals, especially cats because it lets the pets come and go as they please. The introduction of RFID technology opens wide potentialities for automation in animal industry. Home pet owners who live in private houses might also take liking to the amenities of RFID tags. That's where RFID automation comes in. The RFID collar key can be programmed with thousands of key codes, and comes with a shatter-resistant panel, built to withstand plenty of wear. The pet door can be mounted on either an exterior door or wall. As the cat approaches the door, the RFID sensor reads the collar key and slides the pet cage door open and closed, preventing other animals from entering. So the target of this work is to a develop system that can unlock the pets door's electronic lock when the pet with an RFID tag whose ID number is on the prohibited list is nearby. A unique ID code stored in an RFID tag guarantees the 100 percent identification of an animal.

LIST OF CONTENT

CHAPTER CONTENT	PAGE
INTELLECTUAL AND PROPRIETARY RIGHT	2-3
ACKNOWLEDGEMENT	4
ABSTRACT	5
LIST OF CONTENT	6-7
 CHAPTER	
1 INTRODUCTION OF THE PROJECT	8-10
1.1 Introduction	
1.2 Problem statement	
1.3 Objective	
1.4 Research Question	
1.5 Scope project	
1.6 Chapter summary	
 2 LITERATURE REVIEW	 11-20
2.1 Introduction	
2.2 Background of research	
2.3 Item of system	
2.4 Comparison of study	
2.5 Conclusion of chapter	

3 METHODOLOGY.....**21-31**

- 3.1 Introduction
- 3.2 Flowchart
- 3.3 Design process
- 3.4 Process of installing flip door
- 3.5 Data analysis method
- 3.6 Project planning

4 RESULT AND ANALYSIS.....**32-46**

- 4.1 Topic introduction
- 4.2 Coding for system
- 4.3 Problem issue and settlement
- 4.4 Project overview
- 4.5 Circuit diagram

5 DISCUSSION AND CONCLUSION.....**47-49**

- 5.1 RFID and tag reader research
- 5.2 Conclusion
- 5.3 Suggestion

6 REFERENCE.....**50**

CHAPTER 1

INTRODUCTION OF THE PROJECT

1.1 INTRODUCTION

Entry cage doors for cats can give pets the freedom to come and go, also releasing their owners from the time honored tradition of holding cage door open, but cage doors without some type of automation can pose risks for both pets and humans, allowing unwanted visitors. That's where RFID automation comes in. The RFID collar key can be programmed with thousands of key codes, and comes with a shatter-resistant panel, built to withstand plenty of wear. The pet door can be mounted on either an exterior door or wall. As the cat approaches the door, the RFID sensor reads the collar key and slides the pet cage door open and closed, preventing other animals from entering.

1.2 PROBLEM STATEMENT

A cat cage door is found to be convenient by many owners of companion animals, especially cats because it lets the pets come and go as they please, reducing the need for pet owners to let or take the pet outside manually, and curtailing unwanted behaviour such as loud vocalization to be let outside. They also help to ensure that a pet left outdoors can safely get back into the cage in the case of inclement weather. Since many cats tend to be more active at night, cat cage doors can be a blessing for owners hoping to keep to a regular sleep schedule. Engineered to prevent other nuisance animals from entering the cage, the cat cage door is designed specifically so that other animal cannot get their fingers underneath the cage door to lift it up. Using RFID technology, the busiest of pet owners can feed and keep track of their pets without a lot of extra work.

1.3 OBJECTIVE

The objectives of the study will clearly state how the objectives of the study can be achieved. The objectives of this project are :

- To facilitate cats and cats owner
- Not wasting time
- To ensure safety
- It's not harmful

1.4 RESEARCH QUESTION

This study will answer the following research question :

- How the cats would be comfortable with the collar tags put on them?
- How long for cats to familiarize itself with the door?
- What is the distance of the scan reader and the sensor?
- What is the size of a cat that can use this door?
- What sensor does this cage use to unlock the door?

1.5 SCOPE PROJECT

This project focuses on pets especially for cats. It can give the cats freedom to come and go while at the same time also releasing their owners from the time honored tradition of holding cage door open. Its suitable for kittens and an adult cats. We also provided a cat reader tag for RFID scan.

1.6 CHAPTER SUMMARY

The conclusion for this chapter, the problems that happened made us come up with the objective on how to improvise a cat cage door to a new level of safeness. The significance is stated into three categories that could be affected such as institutions, parents and manufacturer. All the data are collected in order to achieve the objectives states

CHAPTER 2

LITERATURE REVIEW

2.1 INTRODUCTION

A literature review is an evaluative report of information found in the literature related to your selected area of study. The review should describe, summarize, evaluate and clarify this literature. It should give a theoretical base for the research and help you (the author) determine the nature of your research. Works which are irrelevant should be discarded and those which are peripheral should look at critically.

A literature review is more than the search for information, and goes beyond being a descriptive annotated bibliography. All works included in the review must be read, evaluated and analyzed. Relationships between the literatures must also be identified and articulated, in relation to your field of research.

2.2 BACKGROUND OF RESEARCH

The introduction of RFID technology opens wide potentialities for automation in the animal industry. For example, feeding every single animal with food that is most appropriate for it or a full guarantee that every animal will be vaccinated. Home pet owners who live in private houses might also take a liking to the amenities of RFID tags. A Cat Cage Door allows the cat to move from indoor to outdoor and back by itself without the need for the owner to open or close the cage door. It must not be locked because the pet must pass through it freely. However, a Cat Cage Door might also be used by a foreign animal or, worse, a perpetrator. Also, it cannot provide appropriate noise and thermal insulation. So the target of this work is to develop a system that can unlock the Cat Cage Door electronic lock when the cat with an RFID tag whose ID number is on the prohibited list is nearby. Serviceability of an RFID tag is limited only by the duration of wearproof of its components. A unique ID code stored in an RFID tag guarantees the 100 percent identification of an animal.

2.3 ITEM OF SYSTEM

ARDUINO UNO



Figure 2.1 : Example of Arduino

The Arduino project started at the Interaction Design Institute Ivrea (IDII) in Ivrea, Italy. At that time, the students used a BASIC Stamp microcontroller at a cost of \$100, a considerable expense for many students. In 2003 Hernando Barragán created the development platform Wiring as a Master's thesis project at IDII, under the supervision of Massimo Banzi and Casey Reas, who are known for work on the Processing language. The project goal was to create simple, low-cost tools for creating digital projects by non-engineers. The Wiring platform consisted of a printed circuit board (PCB) with an ATmega168 microcontroller, an IDE based on Processing and library functions to easily program the microcontroller. In 2003, Massimo Banzi, with David Mellis, another IDII student, and David Cuartielles, added support for the cheaper ATmega8 microcontroller to Wiring. But instead of continuing the work on Wiring, they forked the project and renamed it Arduino. Early arduino boards used the FTDI USB-to-serial driver chip and an ATmega168. The Uno differed from all preceding boards by featuring the ATmega328P microcontroller and an ATmega16U2 (Atmega8U2 up to version R2) programmed as a USB-to-serial converter.

RFID RC522



Figure 2.2 : Example of RFID

Radio-frequency identification (RFID) uses electromagnetic fields to automatically identify and track tags attached to objects. The tags contain electronically stored information. Passive tags collect energy from a nearby RFID reader's interrogating radio waves. Active tags have a local power source (such as a battery) and may operate hundreds of meters from the RFID reader. Unlike a barcode, the tags don't need to be within the line of sight of the reader, so it may be embedded in the tracked object. RFID is one method of automatic identification and data capture (AIDC).

RFID TAGS



Figure 2.3 : Example of RFID Tags

RFID tags are used in many industries. For example, an RFID tag attached to an automobile during production can be used to track its progress through the assembly line; RFID-tagged pharmaceuticals can be tracked through warehouses; and implanting RFID microchips in livestock and pets enables positive identification of animals. Since RFID tags can be attached to cash, clothing, and possessions, or implanted in animals and people, the possibility of reading personally-linked information without consent has raised serious privacy concerns. These concerns resulted in standard specifications development addressing privacy and security issues. ISO/IEC 18000 and ISO/IEC 29167 use on-chip cryptography methods for untraceability, tag and reader authentication, and over-the-air privacy.

RESISTOR

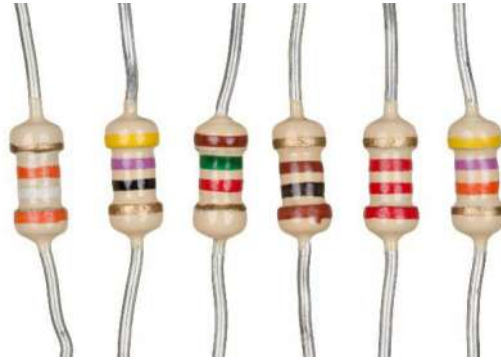

Figure 2.4 : Example of resistor

A resistor is a passive two-terminal electrical component that implements electrical resistance as a circuit element. In electronic circuits, resistors are used to reduce current flow, adjust signal levels, to divide voltages, bias active elements, and terminate transmission lines, among other uses. High-power resistors that can dissipate many watts of electrical power as heat, may be used as part of motor controls, in power distribution systems, or as test loads for generators. Fixed resistors have resistances that only change slightly with temperature, time or operating voltage. Variable resistors can be used to adjust circuit elements (such as a volume control or a lamp dimmer), or as sensing devices for heat, light, humidity, force, or chemical activity.

Resistors are common elements of electrical networks and electronic circuits and are ubiquitous in electronic equipment. Practical resistors as discrete components can be composed of various compounds and forms. Resistors are also implemented within integrated circuits.

The electrical function of a resistor is specified by its resistance: common commercial resistors are manufactured over a range of more than nine orders of magnitude. The nominal value of the resistance falls within the manufacturing tolerance, indicated on the component.

JUMP WIRE

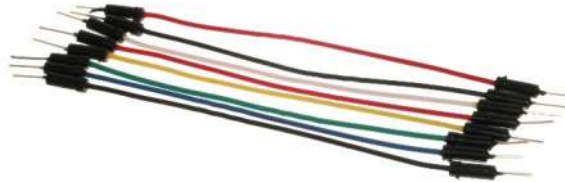

Figure 2.5 : Jump wire that we use in project

Jump wires (also called jumper wires) for solderless bread boarding can be obtained in ready-to-use jump wire sets or can be manually manufactured. The latter can become tedious work for larger circuits. Ready-to-use jump wires come in different qualities, some even with tiny plugs attached to the wire ends. Jump wire material for ready-made or homemade wires should usually be 22 AWG (0.33 mm²) solid copper, tin-plated wire - assuming no tiny plugs are to be attached to the wire ends. The wire ends should be stripped 3/16 to 5/16 in (4.8 to 7.9 mm). Shorter stripped wires might result in bad contact with the board's spring clips (insulation being caught in the springs). Longer stripped wires increase the likelihood of short-circuits on the board. Needle-nose pliers and tweezers are helpful when inserting or removing wires, particularly on crowded boards.

Differently colored wires and color-coding discipline are often adhered to for consistency. However, the number of available colors is typically far fewer than the number of signal types or paths. Typically, a few wire colors are reserved for the supply voltages and ground (e.g., red, blue, black), some are reserved for main signals, and the rest are simply used where convenient. Some ready-to-use jump wire sets use the color to indicate the length of the wires, but these sets do not allow a meaningful color-coding schema.

SOLENOID



Figure 2.6 : Example of solenoid

As a technical term in the study of electromagnetism, a solenoid is a coil that is "pipe-like" in the sense that its length is substantially greater than its diameter. In practice, the coil is often wrapped around a metallic core, which produces a uniform magnetic field in a volume of space (where some experiment might be carried out) when an electric current is passed through it. A solenoid is a type of electromagnet the purpose of which is to generate a controlled magnetic field. If the purpose of the solenoid is instead to impede changes in the electric current, a solenoid can be more specifically classified as an inductor rather than an electromagnet. The solenoid is not necessarily straight, for example, William Sturgeon's electromagnet of 1824 consisted of a solenoid bent into a horseshoe shape.

In engineering, the term may also refer to a variety of transducer devices that convert energy into linear motion. The term is also often used to refer to a solenoid valve, which is an integrated device containing an electromechanical solenoid which actuates either a pneumatic or hydraulic valve, or a solenoid switch, which is a specific type of relay that internally uses an electromechanical solenoid to operate an electrical switch; for example, an automobile starter solenoid, or a linear solenoid, which is an electromechanical solenoid. Solenoid bolts, a type of electronic-mechanical locking mechanism, also exist.

2.4 COMPARISON OF STUDY

	RFID RC522	AS608 Fingerprint Sensor	Bluetooth Module HC-05
Description	RFID means radio-frequency identification. RFID uses electromagnetic fields to transfer data over short distances	Optical fingerprint sensors take low-resolution snapshots of the tip of a finger and create arrays of identifiers that are then used to uniquely identify a given fingerprint	HC-05 is a Bluetooth module which is designed for wireless communication. This module can be used in a master or slave configuration
Working Frequency	13.56MHz	-	2.4GHz ISM band
Supply Voltage	3.3VDC	3.3VDC	3.3VDC
Dimensions	60mm x 39mm	56mm x 20mm x 21.5 mm	26.9mm x 13mm x 2.2mm
Working Temperature	-20 ~ +80 Celsius	-20 ~ +50 Celsius	-20 ~ +75 Celsius
Price	RM 9.80	RM 79.90	RM 14.90

NORMAL CAT CAGE



Figure 2.7 : Example of normal cat cage

Cat owner need to open and lock the cage door every time the cat want to get into or out from the cage.

RFID CAT CAGE DOOR



Figure 2.8 : New cat cage door with RFID

Cat can easily get into and out from the cage by itself without need help from cat owner.

ADVANTAGE:

- Saves energy for cats owner because they do not have to work hard to open and close the cage door.
- Easy for cats to go inside/outside the cage using RFID tag.
- Secured safety from other animals.

DISADVANTAGE:

- The sensor may easy to broke.
- RF Tag may be broke if the cats is raging or scratching.
- Cage doors may be damaged if other cats or animals keep trying to enter inside the cage

2.5 CONCLUSION OF CHAPTER

In conclusion, with new RFID CAT CAGE DOOR that our group created believe it can be give a lot of benefit to pet lovers. Next, parents can saves energy more in daily life and can concentrate doing other things while the cat can easily go and out the cage with RF tag reader. Besides that, they also can facilitate the cats and cats owner. The most important is this RFID CAT CAGE DOOR have a complete new technology that cats owner needed.

CHAPTER 3

METHODOLOGY

3.1 INTRODUCTION

This chapter will cover the details explanation of methodology that is being used to make this project complete and working well. Many methodology or findings from this field mainly generated into journal for others to take advantages and improve as upcoming studies. The method is use to achieve the objective of the project that will accomplish a perfect result. In order to evaluate this project, the methodology based on RFID CAT CAGE DOOR, generally three major step, which is planning, implementing and analysis.

This final year project used three major steps to implement project starting from planning, implementing and testing. All the methods used for finding and analysing data regarding the project related.

3.2 FLOWCHART

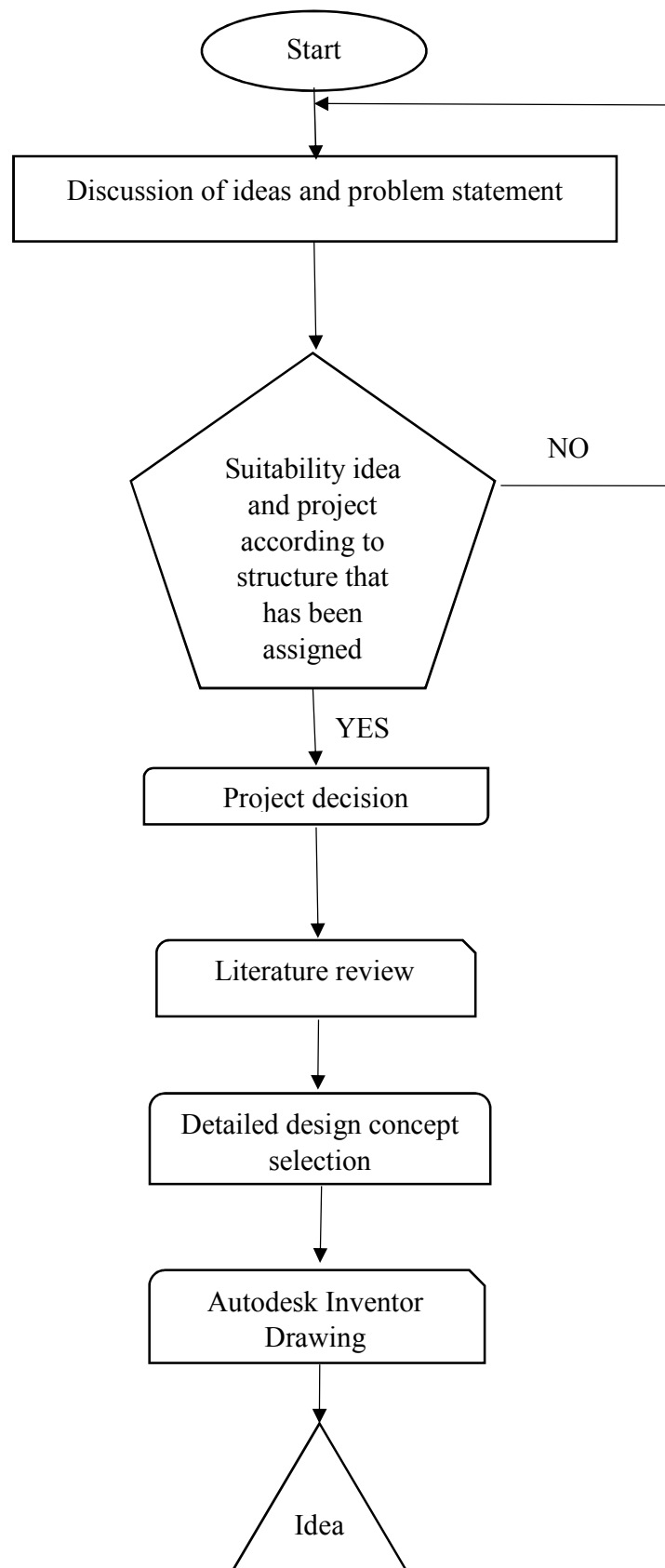

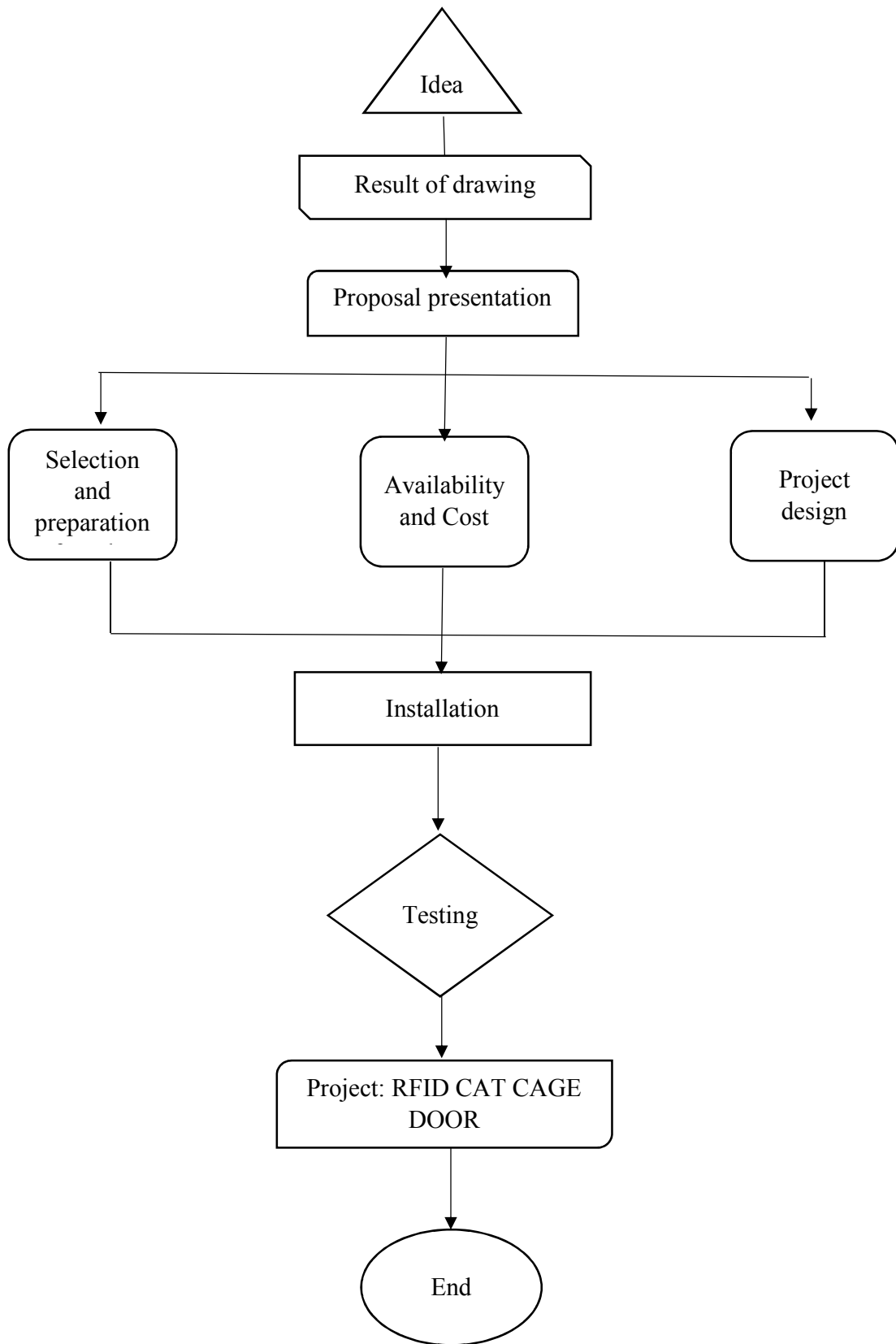

Figure 3.1, 3.2: RFID phase and flow chart of methodology

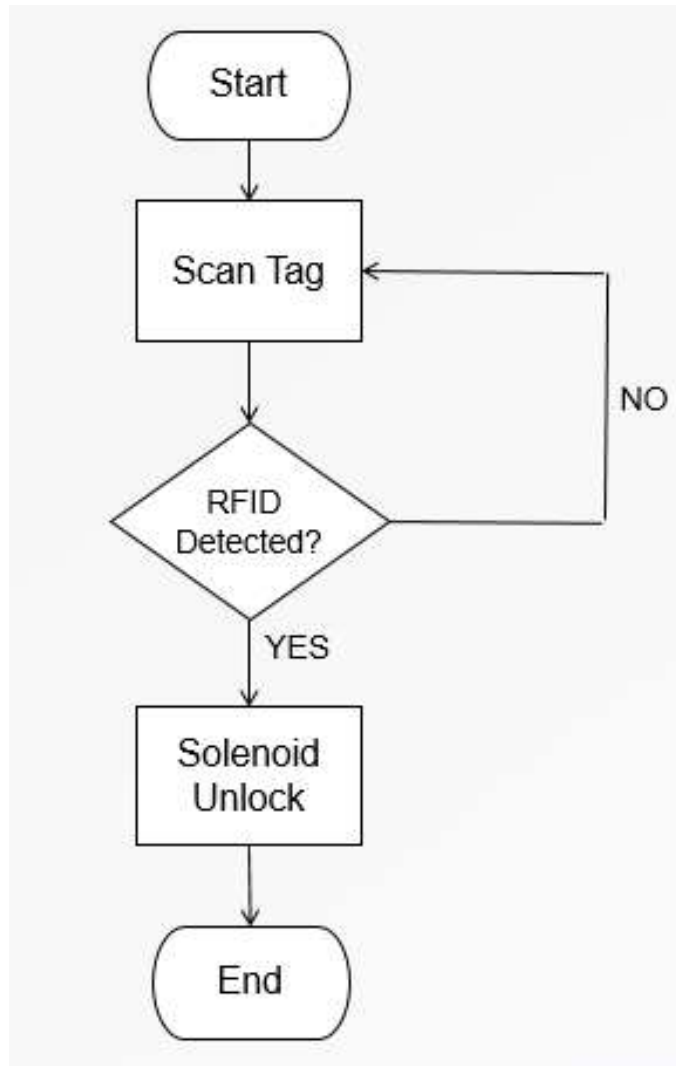

Figure 3.3 : RFID CAT CAGE DOOR flow chart process

3.3 DESIGN PROCESS

Process planning needs to be scrutinized and best condition to produce quality projects or products. Work methods need to be done in a proper and appropriate way to get better and safer results and results. With that method, all the work and tasks performed can be safely and organized. In this chapter, describes methods of producing projects in terms of materials to installation. It aims to control excess production costs and equipment. The steps taken in the production of this project are:

- find the materials and equipment needed to implement this project
- project drawing
- draw the connecting component used
- drafting the project framework
- make tests on the tools provided

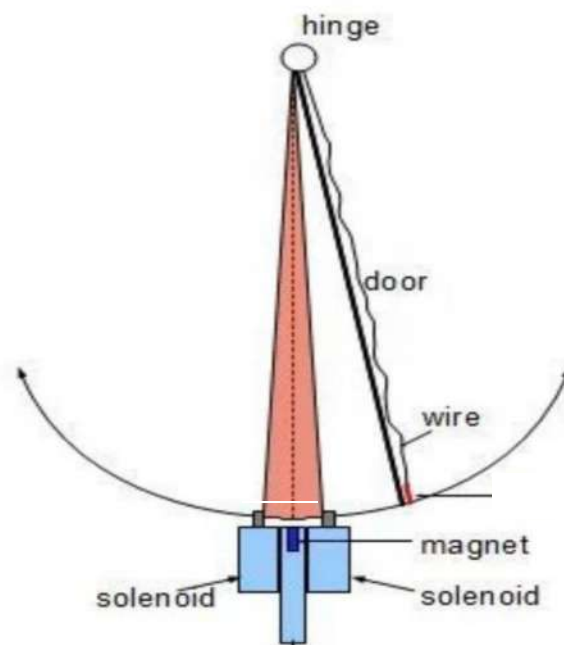

Figure 3.4 : Sketch of project

3. 4 PROCESS OF INSTALLING FLIP DOOR

STEP 1 : Take off the cage door



Figure 3.5 : Cat cage

STEP 2 : Install flip door to the cage door



Figure 3.6 : Flip door installed to the cage door

STEP 3 : Install cat cage door to the cage and put the circuit on cage



Figure 3.6 : RFID Cat Cage Door

3.5 DATA ANALYSIS METHOD

This method means the process of detecting and identifying the form or pattern of data that has been collected to be presented. It is able to identify the relationship between the data before making conclusions and inferences from what is being studied.

1. Questionnaire results

The results of the questionnaires that have been distributed to the public to analyse our data which displayed at chapter 4

2. The use of tools and cost estimates

For estimated costs, we start by collecting money from each group. We have done it in stages. This allows members of the group to be willing to pay and not have any problems while making quotes. On the contrary, it also guarantees the security of money that has been collected from any undesirable possibilities such as theft, loss and so on.

Table 3.5 : Maximum total show our estimate project

Quote	Quantity	Price (RM)	Total (RM)
Session 1	2	RM 100	RM 200
Session 2	2	RM 100	RM 200
Maximum Total			RM 400

For material costs, it's a cost to complete this project. This cost should be recorded correctly. This is because it involves the cost of project hiring. Every invoice received needs to be stored properly.

Item	Price Per Unit (RM)
RFID RC 522	RM 9.90
ARDUINO UNO	RM 26.50
Resistor	RM 13.30
Solenoid	RM 12.98
Wire	RM 8.00
Cage Cat door	RM 30.00
Maximum Total	RM 100.68

Table 3.7 : Expenses to complete our project

3.6 PROJECT PLANNING

This is our Gantt chart for first project before we start actually project.

Weeks / Project Activities	Status	NOV	DEC	JAN	FEB	MAR	APR	MEI	JUN	JUL	AUG	SEP
Briefed about the project	P	■										
	I	■										
Collecting ideas and finalize the project	P	■	■	■								
	I	■	■	■								
Research about the project	P			■	■	■	■					
	I			■	■	■	■					
Knowing the mechanical and electronic base of the project	P			■	■	■						
	I			■	■	■						
Get to know the problems, objective and scope	P		■	■	■							
	I		■	■	■							
Designing tools and calculation of budget	P			■	■	■						
	I			■	■	■						
Detailed drawing of the project	P			■	■	■						
	I			■	■	■						
Presentation of the proposal	P				■	■						
	I				■	■						
Execute the approved project	P				■	■	■					
	I				■	■	■					
Building the project from the base to the electronic and mechanical parts	P					■	■	■	■			
	I					■	■	■	■			
Testing and repair if the failure occur	P							■	■	■	■	
	I							■	■	■	■	
Collecting data	P									■	■	■
	I									■	■	■
Presentation	P											■
	I											■

Table 3.6 : Our Gantt chart for first project

I – Implementation

P – Planning

CHAPTER 4

RESULTS AND ANALYSIS

4.1 TOPIC INTRODUCTION

In this chapter, the model that have been described in chapter 3 to give explanations and give description for the result that have been tested by most of student in the institute. This chapter will give result about how the RFID CAT CAGE DOOR works and how the society response towards this project.

1. What is your gender?

PIE CHART

Male - 52
Female - 48

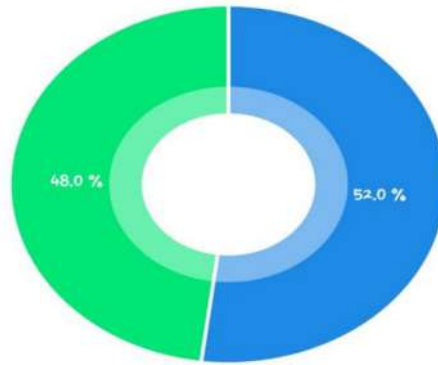

Figure 4.1

2. What is your age?

PIE CHART

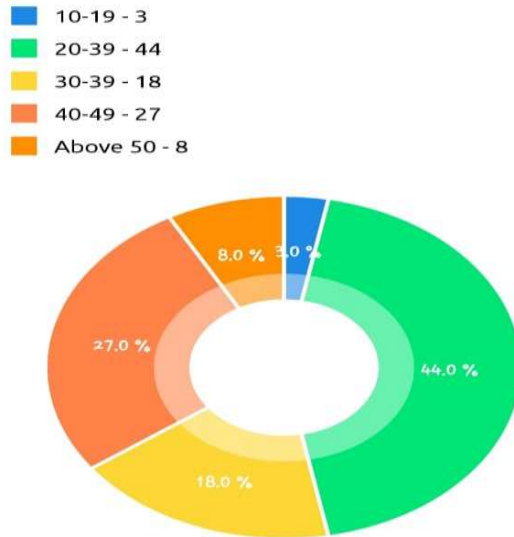

Figure 4.2

It have many people from 20-39 age that answer this survey.

3. Do you have a cat?

PIE CHART

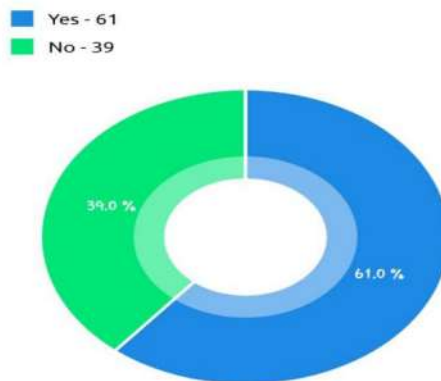

Figure 4.3

61 out of 100 respondents from this survey had cats

4. Do you think that keeping pet is good for you?

PIE CHART

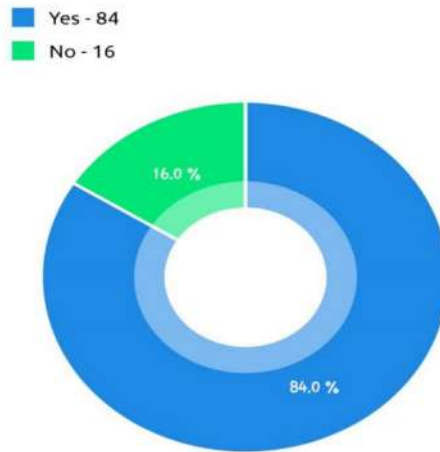

Figure 4.4

Almost 84% choose yes for keeping pet is good for us

5. Do you have any experience where a cat that does not belong to you suddenly come to damaging the cat cage?

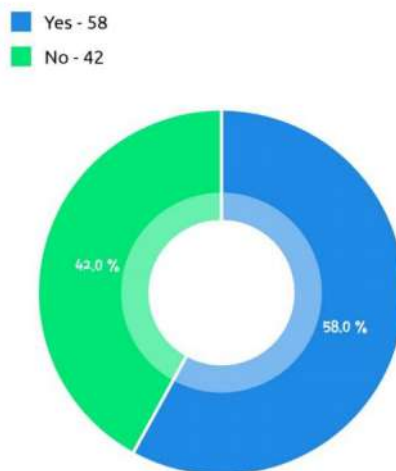

Figure 4.5

58% answered yes that they have experience where a cat that does not belong to us suddenly come to damaging the cat cage

6. Do you think its comfortable for cats to have collar tag around its neck?

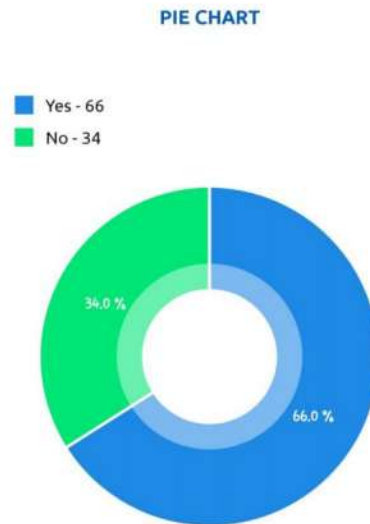

Figure 4.6

66% think that its comfortable for cats to have collar tag around its neck

7. Do you think it will take a longer time for cats familiarize itself with the door?

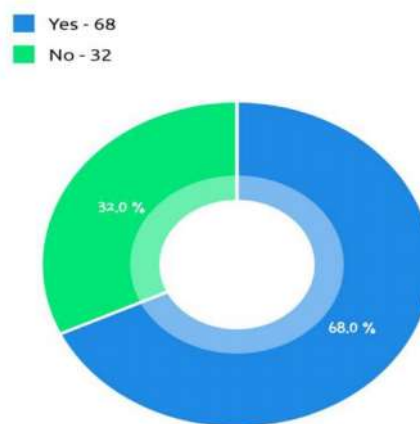

Figure 4.7

68% answered yes that cats take a longer time for familiarize itself with the door

8. Do you agree that this product is good for a busy cat lovers& seldom at home?

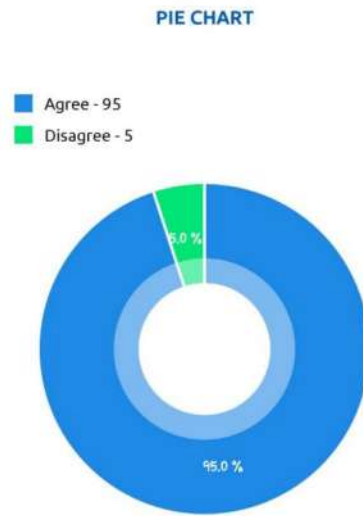

Figure 4.8

95% is agree that this product is good for a busy cat lovers& seldom at home

9, Who did you purchase these products for?

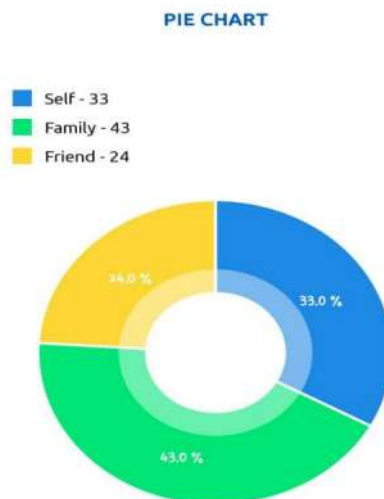

Figure 4.9

43% choose family to purchase these product for

10. Do you think this module is satisfactory?

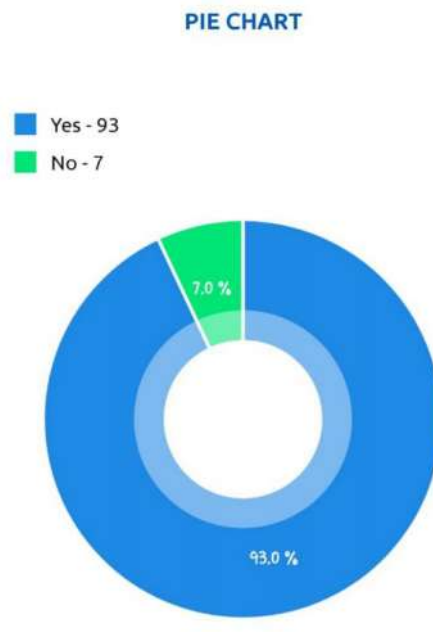

Figure 5.0

93% say yes that this module is satisfactory

11. Do you think this product make easier and save time to users?

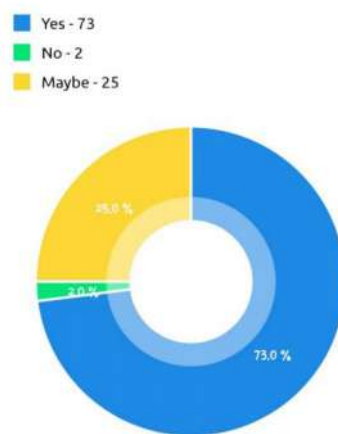

Figure 5.1

73% say yes that this product make easier and save time to users

4.2 CODING FOR SYSTEM

```
//RFID Cat Cage Door
/*
 * Read a card using a mfrc522 reader on your SPI interface
 * Pin layout should be as follows (on Arduino Uno):
 * MOSI: Pin 11 / ICSP-4
 * MISO: Pin 12 / ICSP-1
 * SCK: Pin 13 / ISCP-3
 * SS: Pin 10
 * RST: Pin 9
 */
#include <SPI.h>
#include <MFRC522.h>
#define SS_PIN 10
#define RST_PIN 9

#include <SoftwareSerial.h>

int flag=0;
int op=7;

int LEDRED = 5;
int LEDGREEN= 6;

#define Doorlock_IN 2
#define Doorlock_OUT 3
```

```

char UID2 [] ="A9:32:DD:00";
//char UID3[] ="36:A5:88:F4";
//char UID4[] ="F1:08:78:89";
MFRC522 rfid(SS_PIN, RST_PIN);
MFRC522::MIFARE_Key key;

void setup(){

    pinMode(Doorlock_IN, OUTPUT);
    pinMode(Doorlock_OUT, OUTPUT);
    pinMode(LEDGREEN, OUTPUT);
    pinMode(LEDRED, OUTPUT);

    Serial.begin(9600);
    SPI.begin();
    rfid.PCD_Init();

}

void loop(){

    digitalWrite(LEDGREEN,HIGH); // common LED GREEN ON
    digitalWrite(LEDRED,LOW); // common LED RED OFF

    if ( ! rfid.PICC_IsNewCardPresent())
        return;
    if ( ! rfid.PICC_ReadCardSerial())

```



```

return;
MFRC522::PICC_Type piccType = rfid.PICC_GetType(rfid.uid.sak);
if(piccType != MFRC522::PICC_TYPE_MIFARE_MINI &&
piccType != MFRC522::PICC_TYPE_MIFARE_1K &&
piccType != MFRC522::PICC_TYPE_MIFARE_4K) {
Serial.println(F("Your tag is not of type MIFARE Classic, your tag can't be read :("));
return;
}
String StrID = "" ;
for (byte i = 0; i <4; i ++)
{
StrID +=
(rfid.uid.uidByte[i]<0x10? "0" : "")+
String(rfid.uid.uidByte[i],HEX)+
(i!=3?" ":" ");
}
StrID.toUpperCase();
if(StrID!=UID2)
{
Serial.println("This is an invalid tag :(");
Serial.println("*****");
delay(500);
}

if (StrID==UID2 && flag==0 )
{
flag=1;

```

```

Serial.println(" CAGE DOOR OPEN ");
Serial.println("  Thank You  ");
digitalWrite(LEDGREEN,LOW); // common LED GREEN ON
digitalWrite(LEDRED,HIGH); // common LED RED OFF
digitalWrite(Doorlock_IN,HIGH); // common LED GREEN ON
delay(5000);           // untuk delay masa yg keluar pada LCD 500
digitalWrite(LEDRED,LOW); // common LED RED OFF
digitalWrite(Doorlock_IN,LOW); // common LED GREEN ON

Serial.println("This is a valid tag :");
Serial.println("Status: CAT IN ");
Serial.println("*****");
delay(1000);

}
else if(StrID==UID2 && flag ==1)
{
flag=0;

Serial.println(" CAGE DOOR OPEN ");
Serial.println("  Thank You  ");
digitalWrite(LEDGREEN,LOW); // common LED GREEN ON
digitalWrite(LEDRED,HIGH); // common LED RED OFF
digitalWrite(Doorlock_OUT,HIGH); // common LED GREEN ON
delay(5000);           // untuk delay masa yg keluar pada LCD 500
digitalWrite(LEDRED,LOW); // common LED RED OFF
digitalWrite(Doorlock_OUT,LOW); // common LED GREEN ON

```

```
Serial.println("This is a vaild tag :");  
Serial.println("Status: CAT OUT ");  
Serial.println("*****");  
delay(1000);  
  
rfid.PICC_HaltA ();  
rfid.PCD_StopCrypto1 ();  
  
}  
}
```

In planning an activity and motion related to projects, a discussion within the group to achieve consensus the best has been done for ensure activities, running as planned and orderly. Each week will be held meeting with the project supervisor to discuss the latest developments in relation to the report and the progress of the planned project.

Besides that, all problems encountered such as malfunction project, problems to get information related to projects and others also voiced their views and to seek the best solutions from view our supervisor. All the planning is done carefully. With this, the issues and the development of the project can be shared with others. Queries and problems with the project discussed this point until getting a point solution upon mutual consent.

4.3 PROBLEM ISSUE AND SETTLEMENT

Already one or as perfectly as wherever one is, it will not run away from making mistakes and having problems. The problem is RFID reader to detect the tag at cats collar . Likewise, in carrying out this project, there are several problems such as the aspect of getting electronic components, circuit testing, and failure to display the output as required.

4.3.1 PROBLEMS WITH CODING

We encountered a problem while making coding is to stored information in RFID RC522 because we are not quite proficient in coding chapter. Therefore, the solution to solve this problem is we have requested the help of a few people who specialize and savvy about the chapter this coding.

4.3.2 PROBLEMS WITH PLACED THE CIRCUIT

Arduino Uno and RFID RC522 too exposed , that makes the circuit not save when the product placed at outdoor . So we install casing on Arduino Uno and RFID RC522.

4.3.3 ANOTHER PROBLEM

During the process of designing a project, many aspects which needs to be taken and emphasized so that the resulting product is able to achieve the desired purpose and satisfaction of the user's taste. For example, in the production of this final project product, "RFID Cat Cage Door", many aspects need to be considered.

Among them are: -

1. Reasonable price
2. Useful products to users
3. Quality
4. Manufacturing cost
5. The process involved

4.4 PROJECT OVERVIEW

FRONT VIEW



Figure 5.2

BACK VIEW

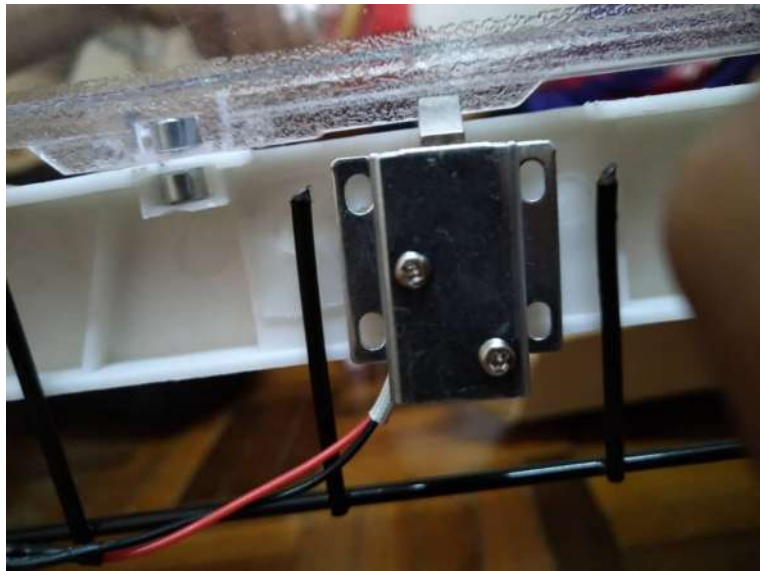

Figure 5.3

4.5 CIRCUIT DIAGRAM

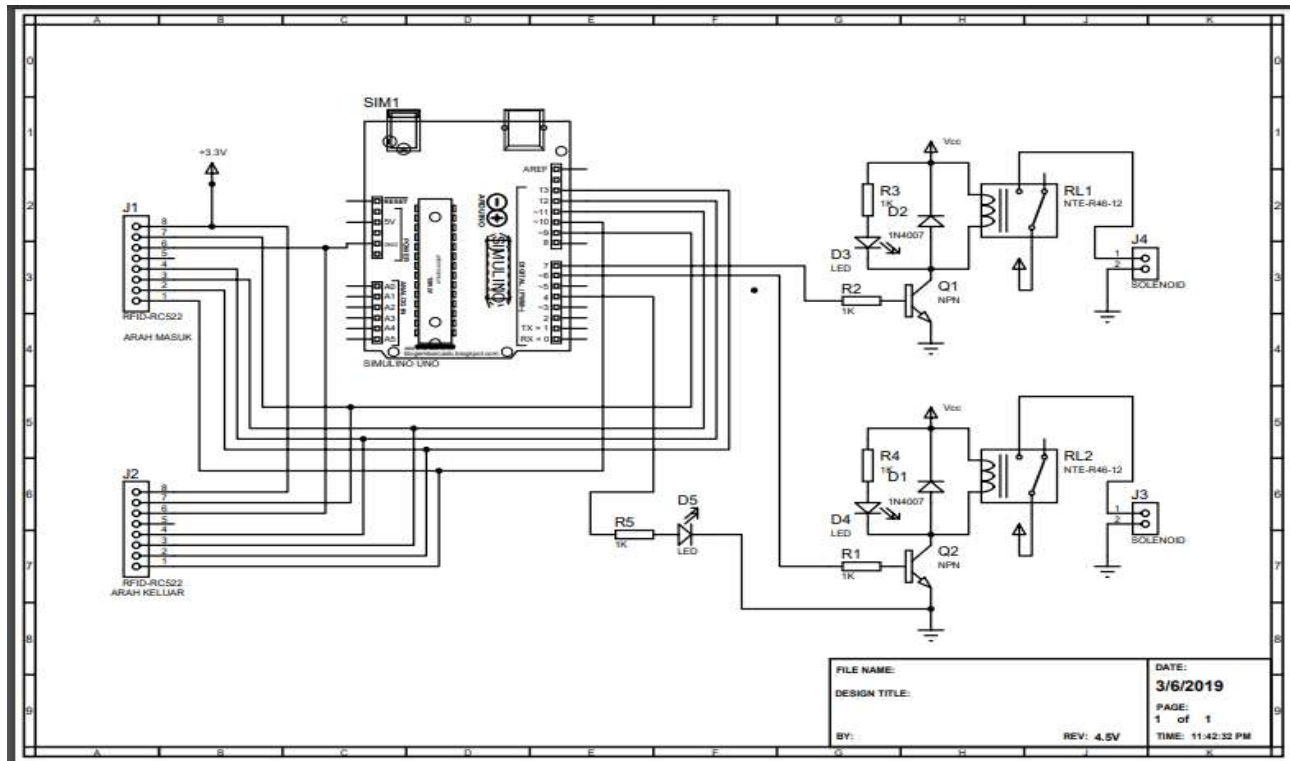

Figure 5.4

CHAPTER 5

DISCUSSION AND CONCLUSION

5.1 RFID & TAG READER RESEARCH

A radio-frequency identification system uses tags, or labels attached to the objects to be identified. Two-way radio transmitter-receivers called interrogators or readers send a signal to the tag and read its response.

RFID tags can be either passive, active or battery-assisted passive. An active tag has an on-board battery and periodically transmits its ID signal. A battery-assisted passive (BAP) has a small battery on board and is activated when in the presence of an RFID reader. A passive tag is cheaper and smaller because it has no battery; instead, the tag uses the radio energy transmitted by the reader. However, to operate a passive tag, it must be illuminated with a power level roughly a thousand times stronger than for signal transmission. That makes a difference in interference and in exposure to radiation.

Tags may either be read-only, having a factory-assigned serial number that is used as a key into a database, or may be read/write, where object-specific data can be written into the tag by the system user. Field programmable tags may be write-once, read-multiple; "blank" tags may be written with an electronic product code by the user.

RFID tags contain at least three parts: an integrated circuit that stores and processes information and that modulates and demodulates radio-frequency (RF) signals; a means of collecting DC power from the incident reader signal; and an antenna for receiving and transmitting the signal. The tag information is stored in a non-volatile memory. The RFID tag includes either fixed or programmable logic for processing the transmission and sensor data, respectively.

An RFID reader transmits an encoded radio signal to interrogate the tag. The RFID tag receives the message and then responds with its identification and other information. This may be only a unique tag serial number, or may be product-related information such as a stock number, lot or batch number, production date, or other specific information. Since tags have individual serial

numbers, the RFID system design can discriminate among several tags that might be within the range of the RFID reader and read them simultaneously.

5.2 CONCLUSION

The process of preparing a carefully planned project is also quite difficult as it comes after a variety of obstacles and problems it can be achieved even if it does not work as desired. The 'RFID CAT CAGE DOOR' project is a result of our observation of cats and cage door. We want the variation in the implementation of the project presented with the method and its application can be used and beneficial to everyone. Perhaps one day our projects can be marketed and become an additional tool in the future even if sophisticated equipment is on the market.

Skills on practical work gained from theoretical learning in the last semester and from here essentially led us to greater and more challenging manufacturing work. Through this exercise, it can nurture the spirit of cooperation and curiosity about something new and also the theoretical learning that puts us in a state that is ready to practice in the future. From here, our project is not complicated in terms of both electronic and mechanical but requires the imagination of manufacturing in the making of this project model.

5.3 SUGGESTION

After completing this 'RFID CAT CAGE DOOR' Project, we can formulate and portray some of our suggestions and views after looking at the results. Among the following suggestions are:

- a) Understand in more detail and depth about the project area to be undertaken.

- b) Obtain views from supervisors or orgs who are more knowledgeable and experienced before starting project work.

REFERENCE

1. https://en.wikipedia.org/wiki/Radio-frequency_identification
2. <https://www.instructables.com/id/RFID-cat-door/>
3. <https://en.wikipedia.org/wiki/Arduino>
4. https://en.wikipedia.org/wiki/Jump_wire
5. <https://en.wikipedia.org/wiki/Solenoid>
6. <https://en.wikipedia.org/wiki/Resistor>
7. <https://lastminuteengineers.com/how-rfid-works-rc522-arduino-tutorial/>
8. <https://components101.com/wireless/rc522-rfid-module>
9. <https://www.lucidchart.com/pages/how-to-make-a-flowchart-in-word>
10. https://en.wikipedia.org/wiki/Pet_door