

POLITEKNIK SULTAN SALAHUDDIN ABDUL AZIZ SHAH

**IOT BASED MONITORING SYSTEM WITH
FEEDER CONTROLLER**

NAME

REGISTRATION NO

**ZAIREE IZZUL HAIKAL BIN
ZAIFUL AMRIL**

08DEP20F2021

JABATAN KEJURUTERAAN ELEKTRIK

SESI 2 2021/2022

POLITEKNIK

SULTAN SALAHUDDIN ABDUL AZIZ SHAH

**IOT BASED MONITORING SYSTEM WITH
FEEDER CONROLLER**

NAME

REGISTRATION NO

ZAIREE IZZUL HAIKAL BIN ZAIFUL
AMRIL

08DEP20F2021

This report submitted to the Electrical Engineering Department in fulfillment of the requirement for a Diploma in Electrical Engineering

JABATAN KEJURUTERAAN ELEKTRIK

SESI 2 2022/2023

CONFIRMATION OF THE PROJECT

The project report titled "IOT BASED MONITORING SYSTEM WITH FEEDER CONTROLLER" has been submitted, reviewed and verified as a fulfills the conditions and requirements of the Project Writing as stipulated

Checked by:

Supervisor's name : ENCIK ABU BAKAR HAFIZ BIN KAHAR

Supervisor's signature:

Date :

Verified by:

Project Coordinator name :

Signature of Coordinator :

Date :

“I acknowledge this work is my own work except the excerpts I have already explained to our source”

1. Signature :

Name : **ZAIREE IZZUL HAIKAL BIN ZAIFUL AMRIL**

Registration Number : **08DEP20F2021**

Date :

DECLARATION OF ORIGINALITY AND OWNERSHIP

TITLE : DESIGN FINGERS EXERGAME TO IMPROVE FINE MOTOR SKILL FOR AUTISTIC CHILDREN USING ARDUINO

SESSION: SESI 1 2022/2023

1. I, **1. ZAIREE IZZUL HAIKAL BIN ZAIFUL AMRIL**

is a final year student of **Diploma in Electrical Engineering, Department of Electrical, Politeknik Sultan Salahuddin Abdul Aziz Shah**, which is located at **Persiaran Usahawan,40140 Shah Alam Selangor Darul Ehsan**. (Hereinafter referred to as 'the Polytechnic').

- 2. I acknowledge that 'The Project above' and the intellectual property therein is the result of our original creation /creations without taking or impersonating any intellectual property from the other parties.
- 3. I agree to release the 'Project' intellectual property to 'The Polytechnics' to meet the requirements for awarding the **Diploma in Electrical Engineering** to me.

Made and in truth that is recognized by;

a) **ZAIREE IZZUL HAIKAL BIN ZAIFUL AMRIL**)
(Identification card No: - 020813060579))
.....
ZAIREE IZZUL HAIKAL BIN ZAIFUL AMRIL

In front of me, **ENCIK ABU BAKAR BIN KAHAR** (Click here to enter text.))
As a project supervisor, on the date:)
ENCIK ABU BAKAR HAFIZ BIN KAHAR

ACKNOWLEDGEMENTS

I have taken efforts in this Project. However, it would not have been possible without the kind support and help of many individuals and organizations. I would like to extend my sincere thanks to all of them. I am highly indebted to (Name of your Organization Guide) for their guidance and constant supervision as well as for providing necessary information regarding the Project & also for their support in completing the Project.

I would like to express my gratitude towards my parents & member of (Organization Name) for their kind co-operation and encouragement which help me in completion of this Project. I would like to express my special gratitude and thanks to industry persons for giving me such attention and time.

My thanks and appreciations also go to my colleague in developing the Project and people who have willingly helped me out with their abilities.

ABSTRACT

Pet is good accompany partner to human. It helps to reduce the stress from living life style and as a precaution to keep away burglars. Nowadays, pet treats as one part of the family member. Therefore, healthy level of the pet need to consider and focus on balance diet. Different size of the pet will have different amount on consuming and different nutrient needed. From the survey, the obesity problem among LI the pet is happened due to pet owner is busy with work. In additional to that, pet doesn't have ability to get the food itself, and it has to depend on the pet owner to feed them. Therefore, Controlled Pet Feeder is created and used to solve the problems feeding the pet on time with required portion. Controlled pet feeder is started popular among the choices of pet owner used to replace the traditional feeding method. The product brings convenience to pet owner by setting the feeding time and portion of the food, which it helps to make sure the pet receives the required diet through a day. The controlled pet feeder trains the pet how to consume food properly and consume at certain time.

ABSTRAK

Haiwan peliharaan adalah teman yang baik untuk menemani manusia. Ia membantu mengurangkan tekanan daripada menjalani gaya hidup dan sebagai langkah berjaga-jaga untuk menjauhkan pencuri. Pada masa kini, perlakuan haiwan peliharaan sebagai sebahagian daripada ahli keluarga. Oleh itu, tahap kesihatan haiwan peliharaan perlu mengambil kira dan memberi tumpuan kepada diet seimbang. Saiz haiwan peliharaan yang berbeza akan mempunyai jumlah yang berbeza pada pengambilan dan nutrien yang berbeza diperlukan. Daripada tinjauan, masalah obesiti dalam kalangan LI haiwan peliharaan berlaku disebabkan pemilik haiwan peliharaan sibuk dengan kerja. Selain itu, haiwan peliharaan tidak mempunyai keupayaan untuk mendapatkan makanan itu sendiri, dan ia perlu bergantung kepada pemilik haiwan untuk memberinya makan. Oleh itu, Feeder Binatang Terkawal dicipta dan digunakan untuk menyelesaikan masalah memberi makan haiwan peliharaan tepat pada masanya dengan bahagian yang diperlukan. Pengumpan haiwan peliharaan terkawal mula popular di kalangan pilihan pemilik haiwan peliharaan yang digunakan untuk menggantikan kaedah pemakanan tradisional. Produk ini memberikan kemudahan kepada pemilik haiwan peliharaan dengan menetapkan masa penyusuan dan bahagian makanan, yang membantu memastikan haiwan peliharaan menerima diet yang diperlukan sepanjang hari. Pengumpan haiwan peliharaan terkawal melatih haiwan peliharaan cara mengambil makanan dengan betul dan mengambil pada masa tertentu.

TABLE OF CONTENTS

CONFIRMATION OF THE PROJECT	i
DECLARATION OF ORIGINALITY AND OWNERSHIP	iii
ACKNOWLEDGEMENTS	iv
ABSTRACT	v
ABSTRAK	vi
TABLE OF CONTENTS	vii
CHAPTER 1	1
1 INTRODUCTION	1
1.1 Introduction	1
1.2 Background Research	1
1.3 Problem Statement	2
1.4 Research Objectives	2
1.5 Scope of Research	3
1.6 Project Significance	3
1.7 Chapter Summary	3
CHAPTER 2	4
2 LITERATURE REVIEW	4
2.1 Introduction	4
2.2 LITERATURE REVIEW 1	4
2.3 LITERATURE REVIEW 2	5
2.4 LITERATURE REVIEW 3	6
2.5 LITERATURE REVIEW 4	7
2.6 Chapter Summary	9
CHAPTER 3	10
3 RESEARCH METHODOLOGY	10
3.1 Introduction	10
3.2 Project Design and Overview.	10
3.2.1 Block Diagram of the Project	11
3.2.2 Flowchart of the Project 2	12
3.3 Project Hardware	13
3.3.1 Schematic Circuit	14
3.3.2 Description of Main Component	15
3.3.2.1 Arduino	15
3.3.2.2 Servo MG995	15
3.3.3 Ultrasonic Sensor	15
3.4 Project Software	16
3.4.1 Flowchart of the System	18
3.4.2 Description of Flowchart	19
3.5 Sustainability Element in The Design Concept	19
CHAPTER 4	21
4 RESULTS AND DISCUSSION	21
4.1 Introduction	21

4.2	Gantt Chart and Activities of the Project during Project 1	22
4.3	Gantt Chart and Activities of the Project during Project 2	23
4.4	Cost and Budgeting	24
CHAPTER 5		25
5	CONCLUSION AND RECOMMENDATIONS	25
5.1	Introduction	25
5.2	Conclusion	25
5.3	Suggestion for Future Work	26
5.4	Project Hardware	28
REFERENCES		29
6	APPENDICES	30
	APPENDIX A – DATA SHEET	30
	<u>APPENDIX B – PROGRAMMING</u>	31

CHAPTER 1

1 INTRODUCTION

1.1 Introduction

This project was created to allow users to control their pets remotely. User will be able to monitor and control their pets even when they are not at home thanks to this project. Users, for example, can give food to their pets just by using a mobile phone application. This project also includes a GPS system for tracking the whereabouts of their pets.

1.2 Background Research

Pet feeders are automated devices designed to dispense food to pets at scheduled times. They can be particularly useful for pet owners who have busy schedules or need to be away from home for extended periods. To conduct background research for a pet feeder, you can explore the following aspects:

Types of pet feeders:

1. Programmable feeders: These feeders allow pet owners to set specific feeding schedules and portion sizes. They often feature digital timers and portion control mechanisms.
2. Smart feeders: These advanced feeders connect to the internet and can be controlled remotely through a smartphone app. They often offer additional features like portion control, feeding history tracking, and notifications.

Feeding schedules and portion control:

1. Different pets have varying dietary requirements and feeding schedules. It's important to consider the specific needs of the pet you're designing the feeder for. Consult veterinarians or pet nutritionists to understand appropriate feeding times and portion sizes for different animals.
2. Some feeders allow you to program multiple feeding times per day, ensuring that the pet receives smaller, regular meals instead of a large portion at once.

This can be beneficial for pets with specific dietary needs or those prone to overeating.

Food storage and capacity:

1. Pet feeders come with different food storage capacities, ranging from small hoppers to large containers. Consider the size and type of pet you are targeting to determine an appropriate storage capacity.
2. Ensure that the feeder's food storage container is airtight and keeps the food fresh for an extended period. This helps to prevent spoilage and maintain the nutritional quality of the food.

Power source and backup options:

1. Pet feeders can be powered by electricity, batteries, or both. Electric feeders need to be plugged into a power source, while battery-operated ones offer more flexibility and can be placed anywhere.
2. It's essential to have backup options, such as battery power or an alternative power source, in case of power outages to ensure that your pet is fed on time.

1.3 Problem Statement

- The problem that users often face is that they find it difficult to feed their pets. For example, when they return to their village or go on vacation, they cannot feed their animals. In addition, they also find it difficult to track their pet's location if their pet is released from the cage.
- As we see nowadays, we only have a pet feeder that using timing. It only follow the timer that been set by the owner. If the food bowl still has the food in it, the system can't detect it and just keep filling the bowl. So, it will be a waste. Different from the timer system, my project will use a connection between owner phone and the pet feeder. Owner just need to use a mobile phone to give their pets food.
- This project will be very helpful to people who have a pets and don't always be at home. For example, workers who works 12 hour or and more.

1.4 Research Objectives

The goal of this project is to teach students how to solve problems utilizing academic research while also gaining knowledge and skills. This assignment is also significant for training and increasing the student's capacity to obtain information, do research, collect data, and finally solve the problem using the processes learned. Aside from that, the project will produce students who are capable of producing a competent

research report in thesis form or technical writing. Furthermore, this programme trains and produces students who are capable of conducting work with minimum supervision and are more independent.

More specifically the principle objective of this research are:

1. Design and fabricate the pet feeder with IOT.
2. Apply the right source code for the device to connect with the this project.
3. To develop project that will help people.

1.5 Scope of Research

1. This Project is focusing on workers and family to feed their pet easily.
2. The emphasis is for people to control the pet feeder from anywhere.
3. The main controller is using ARDUINO UNO.

1.6 Project Significance

This innovation project was developed to help people stay busy and focus on daily tasks outside and at the same time can care about their pet. The aim of this project is the development of new and improved innovation of pet cared. The IoT based monitoring system with pet feeder, as its name suggests, is an innovative solution that combines IoT (Internet of Things) technology with a monitoring and pet feeder. It aims to automate and enhance the care of the pets, offering several significant advantages and benefits.

1.7 Chapter Summary

In summary, IOT based monitoring system with pet feeder will offers a lot of benefits to the user, including time savings, convenience, space optimization, cost savings, and enhanced pet care. Its integration of IoT technology into this project can improve and modernize everyday tasks, ultimately enhancing people's lives while promoting sustainability.

CHAPTER 2

2 LITERATURE REVIEW

2.1 Introduction

This chapter extends the literature reviews that cater the information in accordance with the objectives of this project. The relevant information and other extra features were gathered as shown below.

2.2 LITERATURE REVIEW 1

(Automatic Pet Feeder)

The idea of automatic pet feeder is concerned with a device that feeds food to pets at certain intervals. The timings are actually programmed into the microcontroller. Mann (2015) presents a mechanism for feeding pets even when the owners are absent. For feeding the pets, food has to be loaded first and timings must be set. The remaining work is done by the microelectronic.

In the system, there are three devices that have been used: Two 4. Buzzer of Timing Valves, 2 DC Motors, and ATmega8 Microcontroller. The ATmega8 delivers SRAM's 1K byte, EEPROM's 512 bytes, and In-System Programmable Flash's 8K bytes with capabilities of Read-While-Write. The register contents are saved by the power downmode but the oscillator is frozen by it which disables every other function of chip until the next Hardware Reset or Interrupt.

In the standby mode, the resonator or crystal oscillator is functioning which other parts of the device are not functioning. It enables low consumption of power with a quick start-up. In the setup, a dc motor of 5v is being used. The function of this motor is change the direction of flow of current in the motor part. Most of the types of dc motors produce rotatory motions which motion and force are linearly produced by a linear motor.

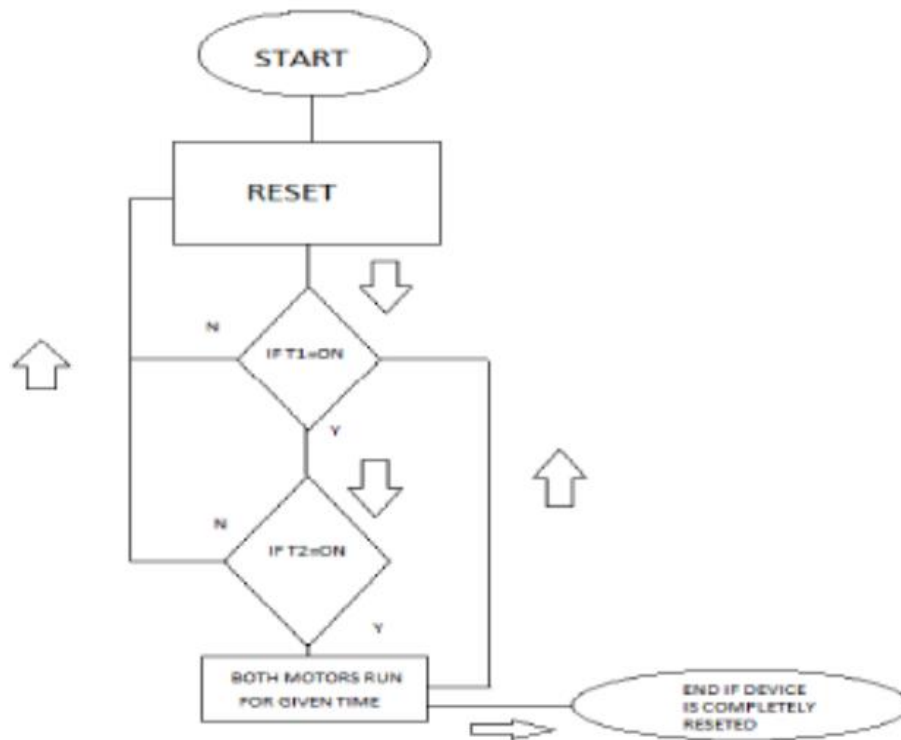

The beeper or buzzer is used in the system which is a device used for audio signaling and it might be piezoelectric, electrochemical, or mechanical. It is explained in the results that every block has been experimented and integrated later on for making the desired device. The microcontroller was programmed successfully using the avr notepad and embedded program c for feeding pets (M, 2015).

2.3 LITERATURE REVIEW 2

(Automatic Pet Monitoring and Feeding System using IoT of Automated Pet Feeding)

It is quite obvious that pets require special care and treatment. However, because of the busy routine, it becomes very difficult to care for pets. S.Subaashri, et al. (2017) present a smart system for pets. The objective of the study is an automatic feeding and monitoring system for pets using IoT or Internet of Things. The proposed system is a complete device for the monitoring of every pet activity while making the pet feel carefree. There are various subdivisions of the project with a unique IR feature. They include system for pet collar, food feeder for pets, and monitoring of pet door.

An IR sensor includes a photodiode and an IR LED in which IR radiations are emitted by the latter and radiations are detected by the former. Whenever light is

detected by the photodiode, current is conducted in a reverse direction and the voltage is changed. Voltage comparator senses this voltage change and output is generated by it. In this security circuit, an IR LED has been placed by the authors in parallel with the photodiode so that light can easily be detected by it.

The pet feeder is capable of keeping the water and food clean until the pet wishes to eat. It has a cover for bowl that closes and opens automatically. The presence of pet is detected by the sensor and the cover is opened which enables only the pet to access the food. Moreover, the collar has a GPS tag which is used for identifying and transmitting the steps of a pet. It has been explained that the present technology is not suitable for providing the best security and indulging delays.

In the hardware kit, Wi-Fi module, Sensors, and Arduino Uno are included. +5V is supplied to Arduino from the adapter. In the system, Arduino is actually acting as the gateway and microcontroller. Depending on the IoT concept, details are sent by Arduino to cloud through the module of Wi-Fi. This data is send to the Phone and NodeMCU automates it. It is explained that IoT is basically a platform that can be used for embedding both hardware and software. Furthermore, it is suggested that mechanism on the basis of SOAF with services of web is the best option for the management of appliances and diversified devices (S.Subaashri, et al., 2017).

2.4 LITERATURE REVIEW 3

(Review of IoT in Pet Management of Automated Pet Feeding)

Jigarmasekar, et al. (2018) explains that humans are exposed to such vast scope of technologies that they couldn't have even imagined it in the past. IoT or Internet of Things is an important and rapidly advancing technology. Furthermore, its vision has only evolved because of the convergence of various methods and technologies such as Embedded Systems, Commodity Sensors, Machine Learning, Real-Time Analytics, and Ubiquitous Communication without Wires.

In other words, it can be said that IoT is a mix of several electronic devices. In the term, the things are actually connected together and they can be realized as the

operations of management, tracing, localization, recognition, and so on. It is not false in the case of management of pets through IoT.

Even though owners of pets are not present, they still can feel the presence of their pets. Using IoT, it has become easier to depend on Smart Machines which are capable of adapting while utilizing external stimuli such as animal behavior, temperature, and so on.

Providing food on a timely basis is the basic responsibility for every pet power. There are countless cases when the owner is unable to accomplish this task. Under such conditions, the smart machine presented by authors can understand the difficulty of situation and remind the owner about it.

There is a functionality of pet monitoring in the device which will notify the owner about the location of the pet as there are many times when the owner is busy with something else and cannot keep a watch on the pet. Relying on this aspect, even notorious pets can be found. There is yet another feature in the device which is referred as automated calling and it can be beneficial in the cases when there is a threat and the owner wants to be notified about it.

It can be used when the owner wishes to have visuals of the pet. Authors have concluded that at present, it has become important for pet owners to take the advantage of development of technologies. Using such technologies, pet owners can leave the care of their pets to the automated devices (Jigarmasekar, et al., 2018).

2.5 LITERATURE REVIEW 4

(Automatic Pet Feeder using Arduino)

At present, countless individuals prefer having pets at their homes. However, their care and feeding becomes an issue when there is a busy schedule at the other hand. In order to resolve this issue, Tiwari, et al. (2018) introduces a system of automatic pet feeding for ensuring that the pet is eating on different intervals. This system consists of feeding bowl, dispenser, servo motor, food storage, and so on.

Arduino is also supported by it for controlling operations automatically. This system can be made even more proficient with the addition of audio box and cameras

for checking the activities of a pet. A machine is featured by the system of automatic pet feeding that is capable of feeding pets almost automatically after relevant time intervals when the master is not even present. With the use of machine, the master doesn't have to stay at the home looking out for the pet. There are several ways through which the dish can be filled for feeding the pet. One of them is setting date and time using the Arduino UNO that is displayed on the screen of LCD.

The components of the automatic feeder include LCD display, Wi-Fi module, T-section of PVC pipe, Acrylic sheets, Arduino UNO, RTC or Real Time Clock, Ky-40 Rotatory Decoder Encoder, and Continuous Servomotor with MG995. Servo motor for continuous rotation is being used with digital modulation.

Arduino UNO sends signals to the motor. It can be said that the shape of AUGER is similar to that of a device used for drilling. Meanwhile, Arduino UNO is actually a board of microcontroller formed on the basis of ATmega328. It contains almost everything that is needed for controlling microcontroller. It means that a simple connection with the computer is required using the cable of USB for feeding the program and getting started. Arduino IDE is used for programming Arduino UNO. It is carried out in such a way that date and time for the system can be set which is highlighted on the screen of LED.

Authors have concluded that automatic feeding can be carried out by connecting Smart Dog Feeder and server with the application of android through communication of Wi-Fi and exchanging messages with the protocol of MQTT. For enforcing the security of communication, the protocol of SSL/TLS is utilized for ensuring that communication between the components cannot be read by the other part. Authors suggest that for the future development, the device can be expanded using a larger dispenser for storing the food of dog and the application can be optimized using new features **(Karyono & Nugroho, 2016)**.

2.6 Chapter Summary

This chapter presents the literature review that was used as a source of knowledge for this project. Literature reviews are useful for methodology studies because they look at the strengths and flaws of previous research in the same topic. Other than that, literature reviews aid in the development of a theoretical framework consisting of research concepts and ideas whose success can be evaluated, as well as providing information for research relevance and consistency

CHAPTER 3

3 RESEARCH METHODOLOGY

3.1 Introduction

The methodology and particular procedures employed in the project research are described in this section. Both qualitative and experimental methodologies are used in the methodology. In order to gain a better knowledge of the project, this part also describes the project's design and the methods that were taken to present an informative view. This research study is carried out in accordance with methodology and following analysis of an appropriate method for a successful advancement.

3.2 Project Design and Overview.

The aim of this project is to design and develop a pet feeder system using the Blynk IoT platform. The pet feeder system will leverage IoT capabilities to provide users with enhanced control, convenience, and energy efficiency in their care of their pets. This overview outlines the key components and features of the project. An Arduino or ESP8266 board will serve as the main microcontroller, responsible for gathering sensor data and controlling the system. Sensors such as ultrasonic sensor will be utilized to detect food level and send notification when the food is low. Motorized mechanisms or servo motors will be employed to automate the feeder controller.

The Blynk mobile app will be used to provide users with a user-friendly interface for monitoring and controlling the system. Users can interact with various widgets to initiate or adjust the timer, receive notifications, and access system settings. Meanwhile, the Blynk cloud server will handle the communication between the mobile app and the system, ensuring seamless data exchange and remote control capabilities.

3.2.1 Block Diagram of the Project

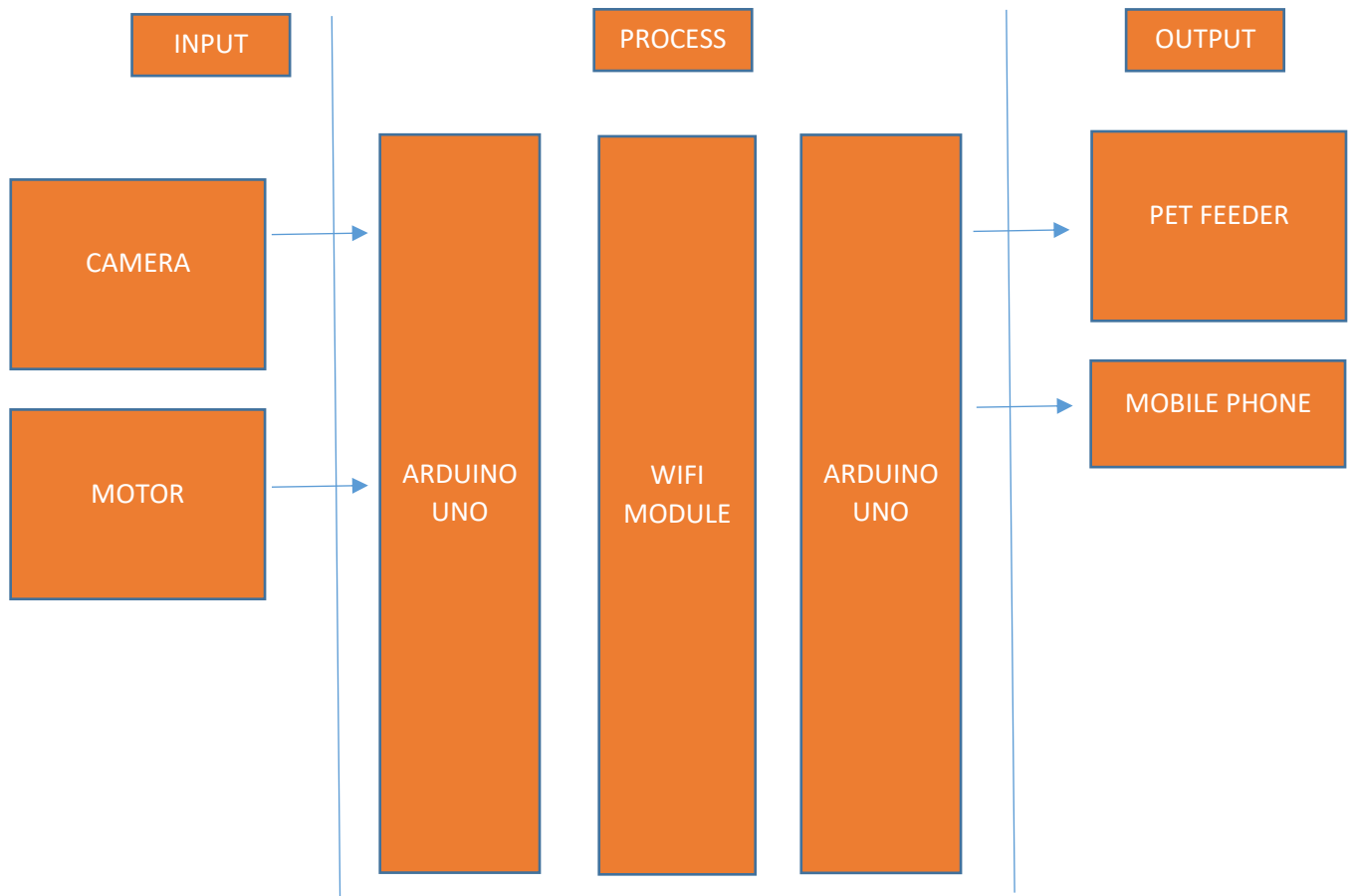

3.2.2 Flowchart of the Project 2

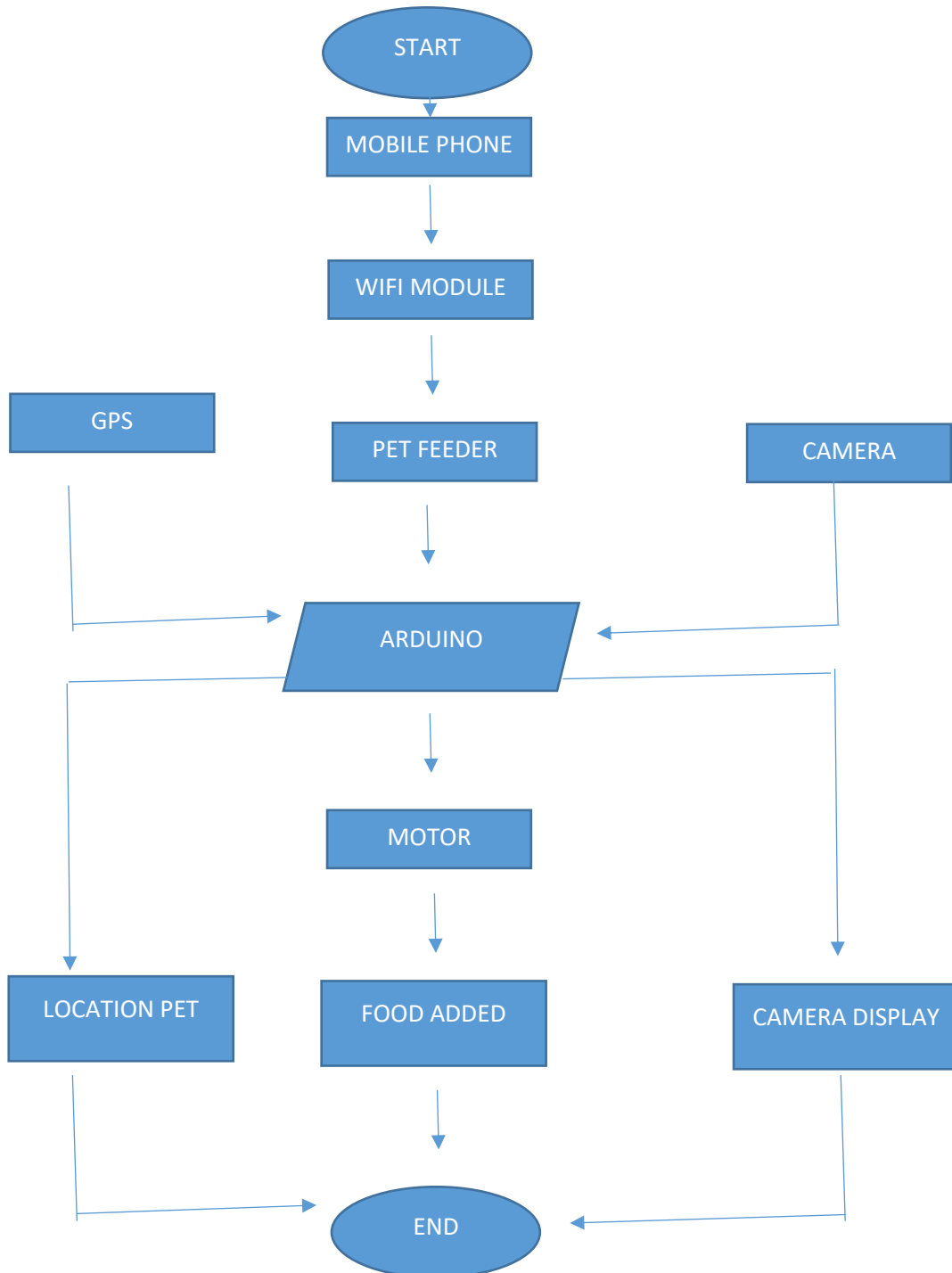

Figure 3.1: Flow chart of operation of the system

*Images may be subject to copyright

3.3 Project Hardware

When designing the hardware for a pet feeder, there are several components and considerations to take into account. Here's a list of key hardware components commonly used in pet feeders:

1. Food storage container: Choose a container that can hold an appropriate amount of pet food and keep it fresh. Consider materials that are safe for storing food, such as BPA-free plastics or stainless steel.
2. Dispensing mechanism: The dispensing mechanism controls the release of food from the storage container into the feeding bowl. There are various types of mechanisms to consider, such as gravity-based mechanisms, auger systems, rotating discs, or conveyor belts.
3. Control system: The control system allows you to program and schedule feeding times, portion sizes, and other settings. It typically includes a microcontroller or a single-board computer like Arduino or Raspberry Pi, which can handle the scheduling logic and communicate with other components.
4. Sensors: Sensors are used to detect various conditions and trigger actions. Some common sensors for pet feeders include:
 - Food level sensor: This sensor measures the amount of food remaining in the storage container and can be used to send notifications when the food is running low.
 - Infrared or ultrasonic sensor: These sensors can be used to detect the presence of the pet near the feeder or to prevent food overflow by detecting if the food bowl is already filled.
5. User interface: An interface is necessary to set up feeding schedules and adjust settings. This can be implemented through buttons, a keypad, an LCD display, or even a touchscreen, depending on the complexity and user-friendliness desired.
6. Motor or actuator: Depending on the type of dispensing mechanism chosen, you may need a motor or actuator to control the movement of the food from the storage container to the feeding bowl.

We need to consider the size, weight, and behavior of the pets you are targeting when choosing and designing these hardware components. Additionally, always prioritize the safety of both the pet and the functionality of the feeder throughout the design process.

3.3.1 Schematic Circuit

Figure 3.2 shows the overall circuit diagram of this Project

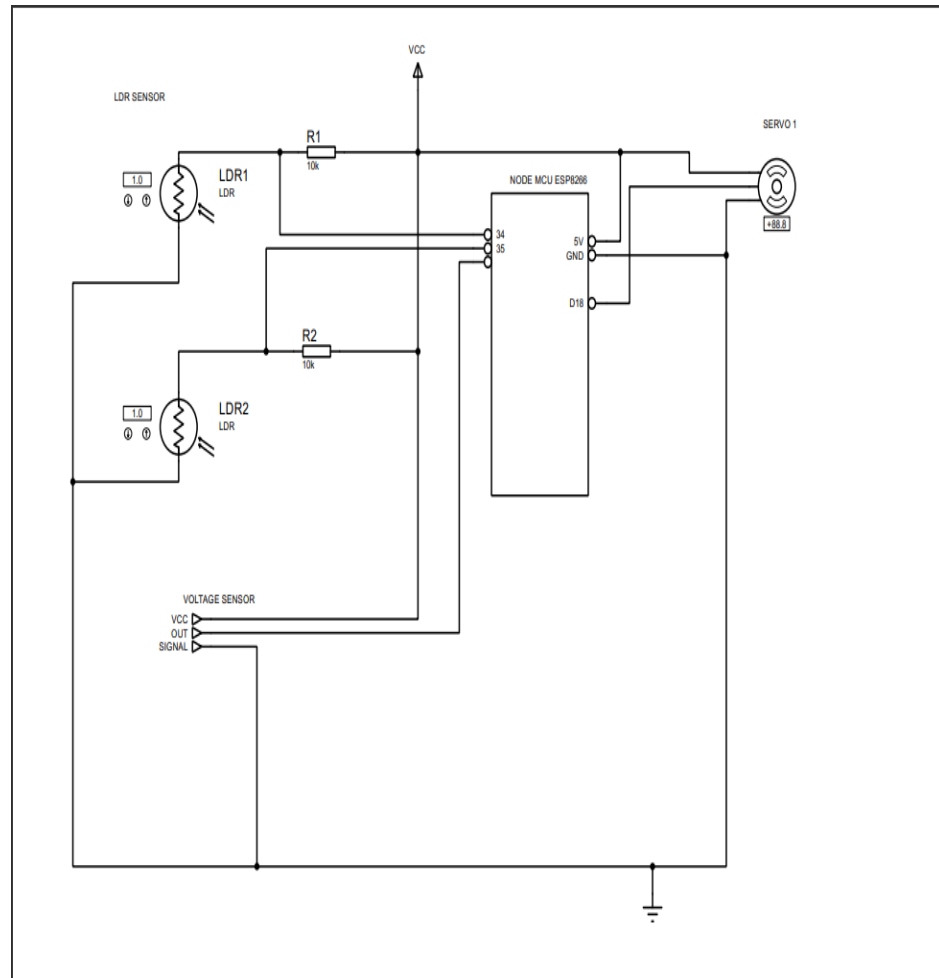

Figure 3.2: Circuit Diagram

*Images may be subject to copyright

3.3.2 Description of Main Component

3.3.2.1 Arduino

Arduino is an open-source electronics platform based on easy-to-use hardware and software. Arduino boards are able to read inputs and turn it into an output - activating a motor, turning on an LED, publishing something online. You can tell your board what to do by sending a set of instructions to the microcontroller on the board. To do so you use the Arduino programming language and the arduino software (IDE), based on processing. its simple and accessible user experience, Arduino has been used in thousands of different projects and applications. The Arduino software is easy-to-use for beginners, yet flexible enough for advanced users. students use it to build low cost scientific instruments, to prove chemistry and physics principles, or to get started with programming and robotics.

3.3.2.2 Servo MG995

- MG995 servo is a simple, commonly used standard servo for your mechanical needs such as robotic head, robotic arm. It comes with a standard 3-pin power and control cable for easy using and metal gears for high torque. A Me RJ25 Adapter also help you to connect the servo with Me Baseboard or Makeblock Orion easily.

3.3.3 Ultrasonic Sensor

- An ultrasonic sensor is an electronic device that measures the distance of a target object by emitting ultrasonic sound waves, and converts the reflected sound into an electrical signal. Ultrasonic waves travel faster than the speed of audible sound (the sound that humans can hear). Ultrasonic sensors have two main components: the transmitter (which emits the sound using piezoelectric crystals) and the receiver (which encounters the sound after it has travelled to and from the target). Ultrasonic sensors are also used as level sensors to detect, monitor, and regulate liquid levels in closed containers (such as vats in chemical factories). Most notably, ultrasonic technology has enabled the medical industry to produce images of internal organs, identify tumors, and ensure the health of babies in the womb.

3.4 Project Software

This project used 2 development software which are:

Proteus 8

The Proteus Design Suite is a proprietary software tool suite used primarily for electronic design automation. The software is used mainly by electronic design engineers and technicians to create schematics and electronic prints for manufacturing printed circuit boards.

The Proteus Design Suite is a Windows application for schematic capture, simulation, and PCB layout design. It can be purchased in many configurations, depending on the size of designs being produced and the requirements for microcontroller simulation. All PCB Design products include an auto router and basic mixed mode SPICE simulation capabilities.

Schematic Capture

Schematic capture in the Proteus Design Suite is used for both the simulation of designs and as the design phase of a PCB layout project. It is therefore a core component and is included with all product configurations.

Microcontroller Simulation

The micro-controller simulation in Proteus works by applying either a hex file or a debug file to the microcontroller part on the schematic. It is then co-simulated along with any analog and digital electronics connected to it. This enables its use in a broad spectrum of project prototyping in areas such as motor control, temperature control and user interface design. It also finds use in the general hobbyist community and, since no hardware is required, is convenient to use as a training or teaching tool. Support is available for co-simulation of:

- Microchip Technologies PIC10, PIC12, PIC16,PIC18,PIC24,dsPIC33 Microcontrollers.
- Atmel AVR (and Arduino), 8051 and ARM Cortex-M3 Microcontrollers

- NXP 8051, ARM7, ARM Cortex-M0 and ARM Cortex-M3 Microcontrollers.
- Texas Instruments MSP430, PICCOLO DSP and ARM Cortex-M3 Microcontrollers.
- Parallax Basic Stamp, Freescale HC11, 8086 Microcontrollers.

PCB Design

The schematic capture module automatically transfers connectivity data in the form of a netlist to the PCB Layout module. This knowledge is put to use, together with user-specified design guidelines and several design automation tools, to help in error-free board design. The size of the design is constrained by the product configuration, and PCBs with up to 16 copper layers can be created

Arduino IDE

The Arduino Integrated Development Environment - or Arduino Software (IDE) – is a software tools that can be use to develop structure code for the Arduino controller. It contains a text editor for writing code, a message area, a text console, a toolbar with buttons for common functions and a series of menus. It connects to the Arduino and Genuino hardware to upload programs and communicate with them.

a) Text Editor

Programs written using Arduino Software (IDE) are called sketches. These sketches are written in the text editor and are saved with the file extension .ino. The editor has features for cutting/pasting and for searching/replacing text. The message area gives feedback while saving and exporting and also displays errors. The console displays text output by the Arduino Software (IDE), including complete error messages and other information. The bottom righthand corner of the window displays the configured board and serial port. The toolbar buttons allow you to verify and upload programs, create, open, and save sketches, and open the serial monitor.

b) Compiler

Compiler is a module that can translate or converting C language programming to the machine language either binary or hex files which will be use by the microcontroller devices.

3.4.1 Flowchart of the System

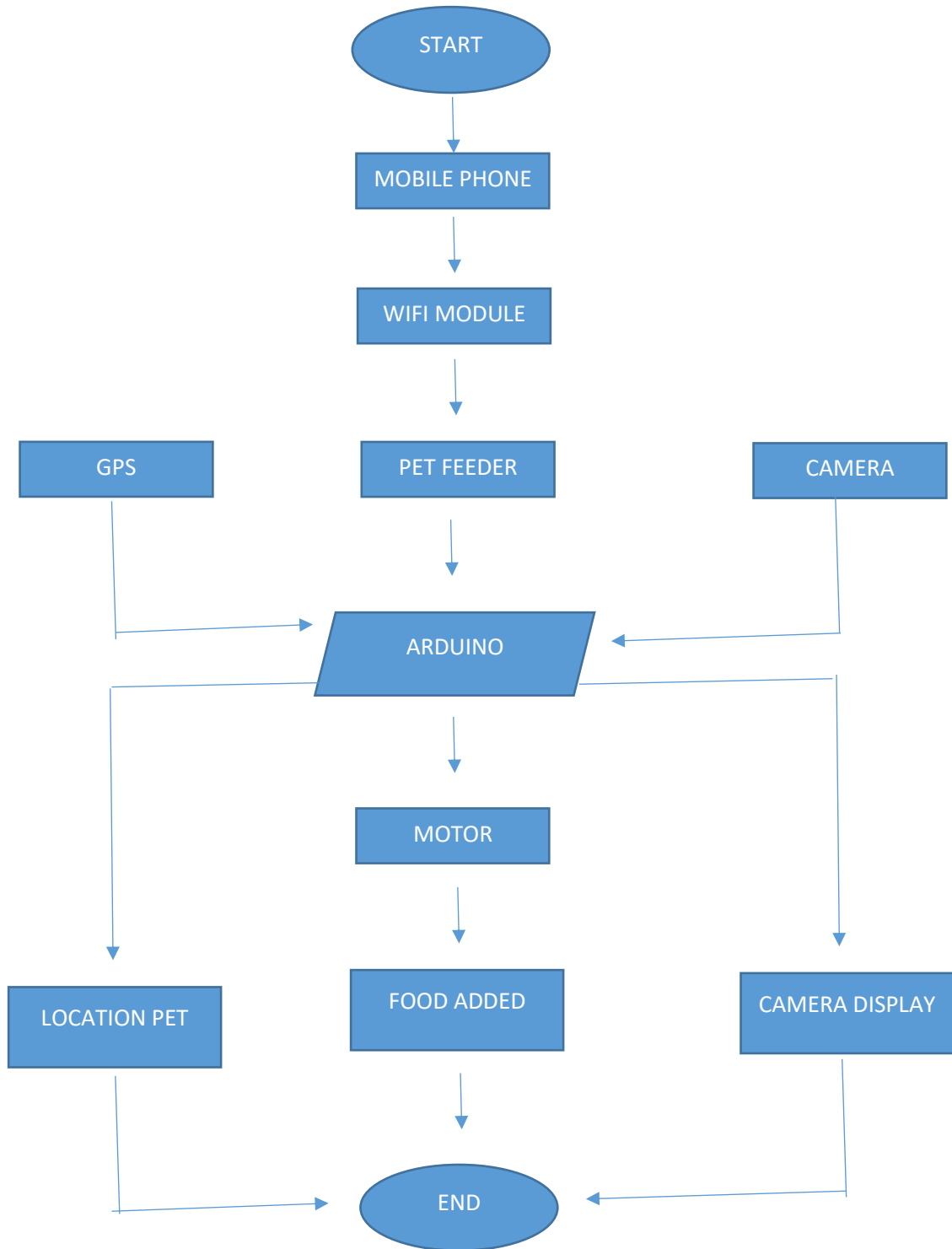

3.4.2 Description of Flowchart

Firstly, the flowchart begins with the start symbol, indicating the beginning of the process. The system initializes, preparing the components and sensors for operation. The flowchart would include a decision symbol to check if any sensors such as ultrasonic sensor, are triggered. If no sensors are triggered, the process continues to the next step. If the sensor triggered, it will send a notification that tell about the level of the food on the food storage.

The motor that controls the feeder movement is activated to start the feeder rotation. A timer is used to determine the duration for feeder to open and close.. The motor controlling the feeder rotation is deactivated, bringing it to a stop. If the laundry is dry, the process moves to the next step. I The flowchart ends with the stop symbol, indicating the end of the process.

3.5 Sustainability Element in The Design Concept

To incorporate sustainability elements into the design concept of a pet feeder, consider the following ideas:

1. **Material selection:** Choose eco-friendly and sustainable materials for the feeder's components. Opt for materials with recycled content or materials that can be easily recycled at the end of the product's life. Use biodegradable or compostable materials where possible, especially for disposable parts.
2. **Energy efficiency:** Design the pet feeder to be energy-efficient by using low-power components and optimizing the power usage. Consider using energy-efficient motors, sensors, and microcontrollers to minimize energy consumption during operation.
3. **Programmable portion control:** Include portion control features in the feeder's design to help reduce food waste. This allows pet owners to accurately dispense the right amount of food, minimizing overfeeding and ensuring that only the necessary amount is provided.
4. **Food storage optimization:** Optimize the design of the food storage container to minimize food spoilage and waste. Consider incorporating features such as airtight seals, moisture control, or separate compartments to keep the food fresh and reduce the need for frequent refills.

5. User education and awareness: Include user guides or information materials that educate pet owners about sustainable pet feeding practices, such as responsible portion control, selecting sustainable pet food options, and reducing food waste.

By incorporating these sustainability elements into the design concept of a pet feeder, we can create a product that not only meets the needs of pet owners but also contributes to a more environmentally friendly and responsible pet care approach.

CHAPTER 4

4 RESULTS AND DISCUSSION

4.1 Introduction

This project's financial resources are self-funded, with several main and basic components. All of the components were purchased through online and electronic shops. Based on the cost projection, it is estimated at RM300.00, with an additional RM200.00 for the component and other materials. The other listing was RM500.00, but these prices are variable and volatile. According to the findings of the investigation, it is feasible and achievable.

4.2 Gantt Chart and Activities of the Project during Project 1

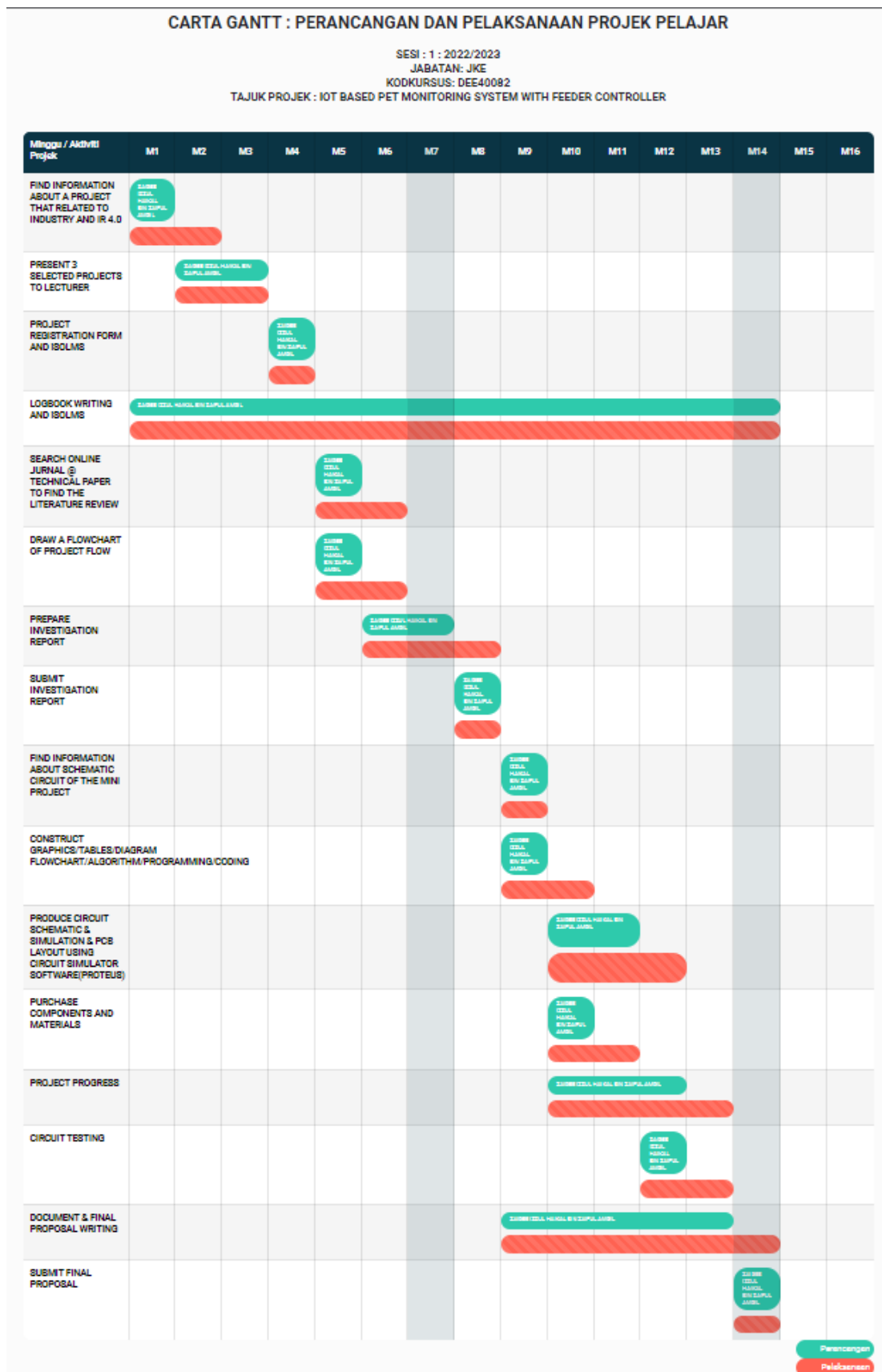

4.3 Gantt Chart and Activities of the Project during Project 2

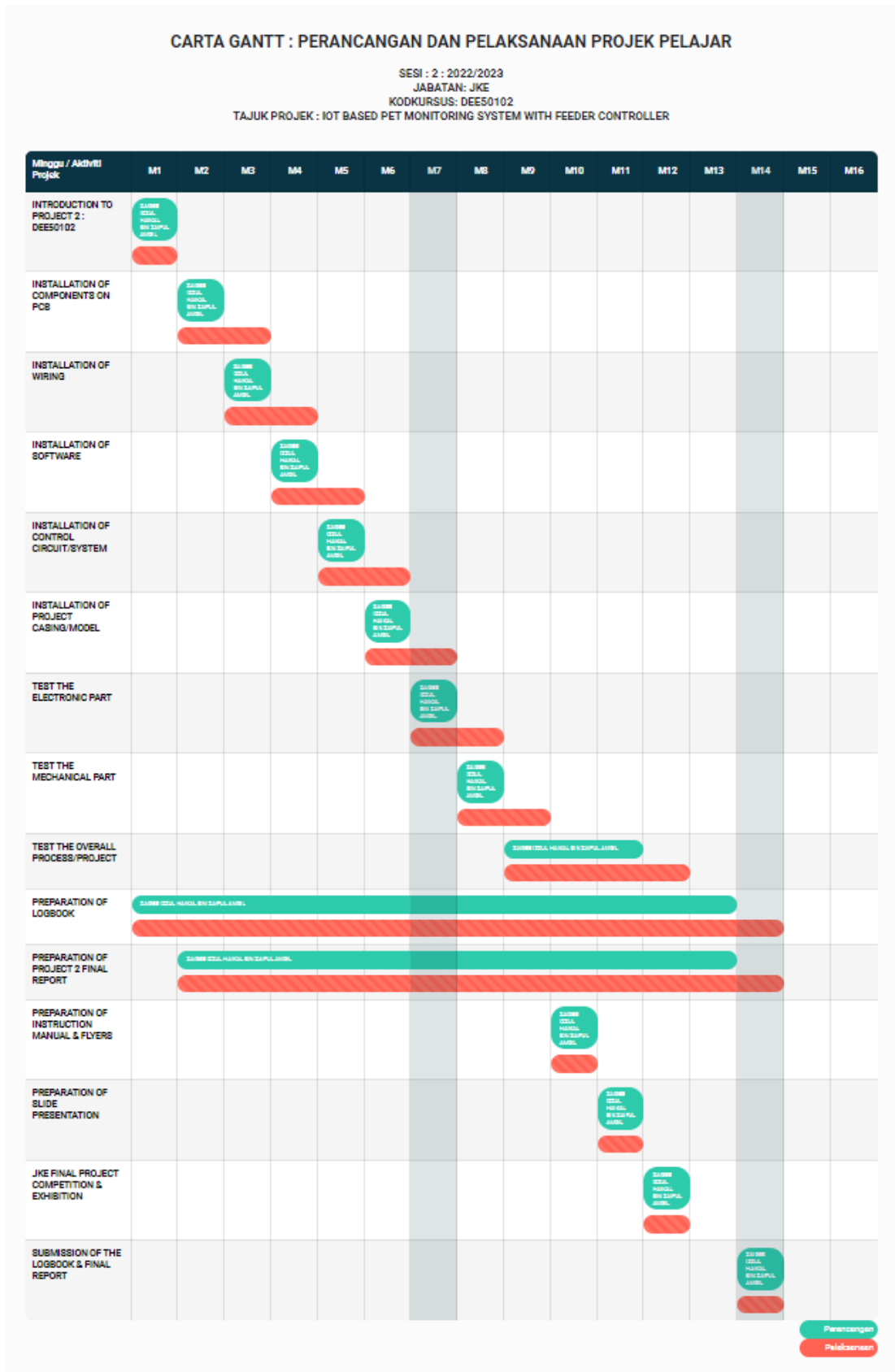

4.4 Cost and Budgeting

This project involves the cost of purchasing components and materials throughout its implementation. components involving cost are hardware Arduino, Servo MG995, Ultrasonic Sensor, ESP8266 Wifi Module, UPS Power Supply, 12V Lead Acid Battery, GPS Module, SIM800L, 2G SIM card, OLED Display, Small 3V battery, Wires and camera. All of these components are purchased through online purchase methods to make it easier as well as save on costs.

The overall gross budget estimate in the implementation of this project is RM 302.80 and other expenses is at RM xxx as shown in Table 1 According to this budget cost, this project is can be considered as a less costly project compared to other projects that can cost over a thousand ringgit. The cost of the project is also in line with one of the key features of a good project developer that is low cost but have a high quality project.

Table 1: List of Components and Materials

No.	Component and materials	The unit price	Quantity	Total
1	Arduino UNO set	RM 23.50	3	RM 70.50
2	Servo MG995	RM 22.00	1	RM 22.00
3	Ultrasonic Sensor	RM 3.00	1	RM 3.00
4	ESP8266 Wifi Module	RM 16.00	1	RM 16.00
7	GPS Module	RM 22	1	RM 22
8	SIM800L	RM 25.00	1	RM 25.00
11	Small 3V battery	RM 10	2	RM 20
12	Camera	RM 25	1	RM 25
13	Other materials	RM 100	-	RM 100
			Total :	RM 303.50
	List of other costing			
1	Transportation	RM 50	-	RM 50
2	Postage	RM 50	-	RM 50
			Total :	RM 100
			Overall total	RM403.50

CHAPTER 5

5 CONCLUSION AND RECOMMENDATIONS

5.1 Introduction

This chapter presents the results obtained from the data analysis which has been made through several questionnaire where testimony is given to both users and Industrial. Apart from that, the whole process of collecting and analyzing data is discussed properly in order to fully understand the problem occurred and how it is solved for a successful project and lastly this chapter will conclude all parts of the project.

5.2 Conclusion

In conclusion, the design of a pet feeder controller plays a crucial role in providing a convenient and reliable feeding solution for pets while addressing various user needs and requirements. By considering the different hardware components and incorporating sustainability elements, a well-designed pet feeder controller can enhance the feeding experience for both pets and their owners.

Key considerations in the design process include selecting appropriate materials that are safe, eco-friendly, and recyclable. Energy efficiency measures and the integration of renewable energy sources can reduce the environmental impact of the pet feeder. Implementing programmable portion control and optimizing food storage can minimize food waste, ensuring pets receive the right amount of food while reducing the need for frequent refills.

A modular and repairable design promotes longevity and allows for easy maintenance, reducing unnecessary waste. Mindful packaging choices and clear instructions on proper disposal or recycling contribute to sustainable practices throughout the product's lifecycle. Additionally, user education and awareness can help promote responsible feeding practices and further reduce environmental impact.

By embracing these design principles, a pet feeder controller can not only provide convenience and peace of mind for pet owners but also contribute to a more sustainable and eco-conscious approach to pet care.

5.3 Suggestion for Future Work

Here are some suggestions for future work and potential improvements in the field of pet feeders:

1. **Integration of AI and machine learning:** Explore the possibility of integrating AI and machine learning algorithms into pet feeders. This could enable the feeder to learn and adapt to the specific dietary needs and eating habits of individual pets, providing personalized feeding recommendations and optimizing portion control.
2. **Health monitoring capabilities:** Consider incorporating health monitoring features into pet feeders. This could include sensors to measure and track a pet's weight, activity levels, and eating patterns. The data collected could be analyzed to provide insights into the pet's health and well-being, allowing pet owners to monitor their pet's overall health and detect any potential issues.
3. **Integration with pet health records:** Explore the integration of pet feeders with digital pet health records or veterinary platforms. This could allow for seamless communication between the feeder and the pet's healthcare provider, enabling better coordination of feeding instructions, medication reminders, and dietary recommendations.
4. **Multi-pet compatibility:** Develop pet feeders that can cater to households with multiple pets. Design the feeder to recognize and differentiate between different pets, allowing for individualized feeding schedules and portion control for each pet.
5. **Advanced connectivity and control:** Further enhance the connectivity features of pet feeders by integrating with smart home systems or voice assistants. This would enable pet owners to control and monitor the feeder through voice commands or mobile apps, providing greater convenience and accessibility.
6. **Enhanced user interface and customization:** Focus on improving the user interface of pet feeders to make them more intuitive and user-friendly. Allow

for easy customization of feeding schedules, portion sizes, and other settings to accommodate the specific needs of each pet.

7. Collaboration with pet food manufacturers: Collaborate with pet food manufacturers to develop compatible systems that provide tailored feeding options based on specific pet food brands or formulations. This would ensure that the feeder dispenses the appropriate portion sizes and maintains the freshness of the food.
8. Environmental impact reduction: Continue to prioritize sustainability in the design of pet feeders by exploring ways to further reduce energy consumption, incorporate more recyclable materials, and minimize waste generation throughout the product's lifecycle.

These future work suggestions aim to enhance the functionality, usability, and overall experience of pet feeders while promoting the well-being and health of pets. By continuing to innovate in these areas, pet feeders can become even more advanced and tailored to the unique needs of both pets and their owners.

5.4 Project Hardware



REFERENCES

1. [1.\[1\] K. N. Khamil,S. I.A. Rahman,M. Gambilok, ARPNJournalofEngineeringandAppliedSciences\(2015\)](#)
2. [1.\[2\] Hajar Abedi,Clara Magnier,Vishvam Mazumdar,George ShakerEngineeringReports\(2021\)](#)
3. [1.\[3\] K. N. Khamil,S. I.A. Rahman,M. Gambilok, ARPNJournalofEngineeringandAppliedSciences\(2015\)](#)
4. [1.\[4\] N. M.Z. Hashim,H. H. Basri,A. Jaafar,M. Z.A.A. Aziz,A. Salleh,A. S. Ja'afar, ARPNJournalofEngineeringandAppliedSciences\(2014\)](#)
5. <https://www.deviceplus.com/arduino/make-a-smart-automatic-pet-feeder-with-arduino-uno/>
6. <https://all3dp.com/2/arduino-pet-feeder-cat-dog/>

6 APPENDICES

APPENDIX A – DATA SHEET



APPENDIX B – PROGRAMMING

```
#include <Servo.h>

// Template ID, Device Name and Auth Token are provided by the
Blynk.Cloud
// See the Device Info tab, or Template settings
#define BLYNK_TEMPLATE_ID "TMPL6j0JiWd80"
#define BLYNK_TEMPLATE_NAME "Quickstart Template"
#define BLYNK_AUTH_TOKEN "DzCS2qDaeQgrHzqFjet4z-uctNUs6fuw"

// Comment this out to disable prints and save space
#define BLYNK_PRINT Serial

#include <WiFi.h>
#include <WiFiClient.h>
#include <BlynkSimpleEsp32.h>

#define ESPADC 4096.0 //the esp Analog Digital Conversion value
#define ESPVOLTAGE 3300 //the esp voltage supply value

#define vCalibration 83.3
#define currCalibration 0.50

Servo myservo;

int pos = 0;
int mode=0;
int SECURITY=0;
float LDR1=0;
float LDR2=0;

// Potentiometer is connected to GPIO 34 (Analog ADC1_CH6)
const int potPin = 34;
```

```

const int potPin2 = 35;
const int potPin3 = 32;
const int potPin4 = 33;
const int potPin5 = 25;

float LIGHTAVG=0;
float VOLTAGE=0;
float ADC1,ADC2,ADC3,ADC4;
float temperature = 25;
float h=0,t=0;
float hx=0,tx=0;
// variable for storing the potentiometer value
int potValue = 0;

int PIRSTAT=0;
int BIT=0;
int ALM1=0,ALM2=0,ALM3=0,ALM4=0;
int Ready=0;
int Ml=0;
String MinS="00";
String HourS="00";
String SecS="00";
int DataIn=0;
String DATA="";
String Temp1x="";
String PHx="";
String Temp2x="";
String Temp1y="";
String PHy="";
String Temp2y="";
String Temp3y="";
String Temp3x="";
String Temp4y="";
String Temp4x="";
String currentTime;
String currentDate;
String TimerGet="00:00:00";
int MODE=0;
int Hour=0;
int Min=0;

int Sec=0;
float CO2;
float FLAME=0;
float LEVEL=0;
int ALM=0;
int Val=100;

```

```

int Index=0;
float CV=0;
int CKN=0;
float LDRAVG=0;
//-----
int TDIS=0;
int Rly1=0;
int wait=0;
int Rly2=0;
int Rly3=0;
int Rly4=0;
int Rly5=0;

//-----

char auth[] = BLYNK_AUTH_TOKEN;

// Your WiFi credentials.
// Set password to "" for open networks.
char ssid[] = "SOLAR";
char pass[] = "12345678";

BlynkTimer timer;

// This function is called every time the Virtual Pin 0 state changes

BLYNK_WRITE(V10)
{
  int pinValue = param.asInt(); // assigning incoming value from pin V1
to a variable
  Rly1=pinValue;
  if (pinValue==1){

  }
  if (pinValue==0){

  }

}

BLYNK_WRITE(V11)
{
  int pin2Value = param.asInt(); // assigning incoming value from pin
V1 to a variable
  Rly2=pin2Value;

```

```

    // process received value
}
BLYNK_WRITE(V12)
{
    int pin3Value = param.asInt(); // assigning incoming value from pin
V1 to a variable
    Rly3=pin3Value;
}

BLYNK_WRITE(V13)
{
    int pin4Value = param.asInt(); // assigning incoming value from pin
V1 to a variable
    Rly4=pin4Value;
}

BLYNK_WRITE(V14)
{
    int pin5Value = param.asInt(); // assigning incoming value from pin
V1 to a variable
    Rly5=pin5Value;

    // process received value
}
//-----
-----

// This function is called every time the device is connected to the
Blynk.Cloud
BLYNK_CONNECTED()
{
}

void myTimerEvent()
{
    //-----
    -
static unsigned long timepoint = millis();

    if (millis() - timepoint > 1000U) //time interval: 1s
    {

```

```

    LDR1 = analogRead(potPin)/ ESPADC * ESPVOLTAGE; // read the voltage
    LDR1=100-(LDR1/3299*100);
    LDR2 = analogRead(potPin2)/ ESPADC * ESPVOLTAGE; // read the
voltage
    LDR2=100-(LDR2/3299*100);
    VOLTAGE = analogRead(potPin3)/ ESPADC * ESPVOLTAGE; // read the
voltage
    VOLTAGE=(VOLTAGE/3299*100);

if (LDR1>LDR2+5 && pos<135){
    pos++;
    myservo.write(pos);
}

if (LDR1<LDR2-5 && pos>45){
    pos--;
    myservo.write(pos);
}

//-----

    Serial.print(LDR1);
    Serial.print("\t");
    Serial.println(LDR2);

    LIGHTAVG=(LDR1+LDR2/2);

delay(100);

Blynk.virtualWrite(V0,LDR1);
Blynk.virtualWrite(V1,LDR2);
Blynk.virtualWrite(V2,LIGHTAVG);

```

```

Blynk.virtualWrite(V3,VOLTAGE);

}

//-----
}

void setup()
{

  int i,k;
  myservo.attach(18);

delay(1500);
  Serial.begin(9600);

  Blynk.begin(auth, ssid, pass);
  // You can also specify server:
  //Blynk.begin(auth, ssid, pass, "blynk.cloud", 80);
  //Blynk.begin(auth, ssid, pass, IPAddress(192,168,1,100), 8080);

  // Setup a function to be called every second
  timer.setInterval(1000L, myTimerEvent);
  for (pos = 0; pos <= 180; pos += 1) { // goes from 0 degrees to 180
degrees
    // in steps of 1 degree
    myservo.write(pos);           // tell servo to go to position in
variable 'pos'
    delay(15);                   // waits 15ms for the servo to
reach the position
  }
}

```

```
    for (pos = 180; pos >= 90; pos -= 1) { // goes from 180 degrees to 0
degrees
        myservo.write(pos);           // tell servo to go to position in
variable 'pos'
        delay(15);                    // waits 15ms for the servo to
reach the position
    }
    pos=90;
    delay(1000);
}

void loop()
{

    Blynk.run();
    timer.run();

}
```

APPENDIX C – PRODUCT POSTER



POLITEKNIK
MALAYSIA
SULTAN SALAHUDDIN ABDUL AZIZ SHAH



ELECTRICAL & ELECTRONIC ENGINEERING C
FIGHT THE POWER
JOIN THE RESISTANCE
INNOVATION COMPETITION

NAME : ZAIREE IZZUL HAIKAL BIN ZAIFUL AMRIL
MATRIX NO : 08DEP20F2021

1. Introduction ✕

This project was created to allow users to control their pets remotely. User will be able to monitor and control their pets even when they are not at home thanks to this project. Users, for example, can give food to their pets just by using a mobile phone application. This project also includes a GPS system for tracking the whereabouts of their pets.

2. Objective ✕

- Giving food to their pets
Users simply press a button on the mobile phone app to fill up the food.
- Monitoring their pets
Users can monitor the pets cage area through a camera that has been programmed using the phone.
- Track Animal Locations
Placing the GPS device on the pet's collar.

3. Scope of Project ✕

- House pets
etc : cats and dogs
- Worker
- Family



PROJECT 2

**IoT Based Monitoring System With Feeder
Controller**